

User Manual

LV52

In order to prevent improper operation before use, please carefully read this manual.

The user manual version is updated frequently, the latest version can be downloaded from the official website.

Table of Contents

1. Introduction	1
2. Symbols	1
3. Safety	2
3.1 Handling	2
3.2 Installation	2
3.3 Response to Emergency Situations	2
4. Product Information	4
4.1 Battery Module Specifications	4
4.2 Battery Charge/discharge Curve	4
5. Product Features	5
5.1 Battery System Features	5
6. Installation	7
6.1 Items in the package	7
6.2 Clearance	9
6.3 Tools	9
6.4 Installation Steps	10
6.5 System Start up	13
7. Commissioning	14
8. Exclusion	17
9. Troubleshooting and Maintenance	18
9.1 Maintenance	18
9.2 Troubleshooting	18

1. Introduction

The document describes the installation, commissioning, maintenance and troubleshooting of the following low voltage battery listed below.



- LV52

The battery chemistry of this product is Lithium Iron Phosphate. This manual is designed for qualified personnel only. The tasks described in this document should be performed by authorized and qualified technicians only.

After Installation the Installer must explain the user manual to the end user.

2. Symbols

	Symbol Explanation CE mark. The inverter complies with the requirements of the applicable CE guidelines.
	This mark indicates compound UK product safety certification requirements.
	Caution, risk of electric shock.
	Do not place nor install near flammable or explosive materials.
	Install the product out of reach of children.
	Read the instruction manual before starting installation and operation.
	Do not dispose of the product with household wastes.
	Recyclable.
	Disconnect the equipment before carrying out maintenance or repair.
	Observe precautions for handling electrostatic discharge sensitive devices.

	PE conductor terminal
	Caution, risk of electric shock, energy storage timed discharge.

3. Safety

Any work on the Batteries should be handled by authorized technicians and hence it is understood that the technicians should familiarize themselves with the contents of this manual before any maintenance or installation is carried out on the system.

3.1 Handling

- Do not expose battery to open flame.
- Do not place the product under direct sunlight.
- Do not place the product near flammable materials. It may lead to fire or explosion in case of accident.
- Store in a cool and dry place with ample ventilation.
- Do not store the product near water sources.
- Store the product on a flat surface.
- Store the product out of reach of children and animals.
- Do not damage the unit by dropping, deforming, impacting, cutting or penetrating with a sharp object. It may cause leakage of electrolyte or fire.
- Do not touch any liquid spilled from the product. There is a risk of electric shock or damage to skin.
- Always handle the battery wearing the insulated gloves.
- Do not step on the product or place any foreign objects on it. This can result in damage.
- Do not charge or discharge damaged battery.
- Do not store the battery near water sources.

3.2 Installation

- Do not connect the LV52 to inverter conductors or Photo-Voltaic conductors. This will damage the battery and may result in explosion.
- After unpacking, please check the product for damages and missing parts.
- Make sure that the inverter and battery is completely turned off before commencing installation.
- Do not interchange the positive and negative terminals of the battery.
- Ensure that there is no short circuit of the terminals or with any external device.
- Do not exceed the battery voltage rating of the inverter.
- Do not connect the battery to any incompatible inverter.
- Do not connect different battery types together.
- Please ensure that all the batteries are grounded properly.
- Do not open the battery to repair or disassemble. Only manufacturer is allowed to carry out any such repairs.
- In case of fire, use only dry powder fire extinguisher. Liquid extinguishers should not be used.
- Install the batteries only inside approved manufacturer enclosure. Installing the battery anywhere outside is strictly forbidden.
- Do not install the battery near water sources or places where the battery can get wet.
- Install the battery away from children or pets.
- Do not use battery in high static environment where the protection device might be damaged.
- Do not install with other batteries or cells.

3.3 Response to Emergency Situations

The battery can be used in single or multi in parallel. It is designed to prevent hazards or failures. However, manufacturer cannot guarantee their absolute safety.

Under exposure to the internal materials of the battery the following recommendations should be carried out by the user.

- If there has been inhalation, please leave the contaminated area immediately and seek medical attention.

- If there has been contact with eyes, rinse the eyes with running water for 15 minutes and seek medical attention immediately.
- If there has been contact with the skin, wash the contacted area with soap thoroughly and seek medical attention immediately.
- If there has been ingestion, induce vomiting and seek medical attention.

Fire Situation

In situations where the battery is on fire, if it is safe to do so, disconnect the battery pack by turning of the switch to shut off the power to the system (External, if any) .Use FM-200 or Co2 fire extinguisher for the battery and an ABC fire extinguisher for the other parts of the system.

Under any fire situation, please evacuate the people from the building immediately before trying to extinguish it.

Water Situation

The battery modules are not water resistant. Hence care should be taken not to get it wet. If you find the battery completely or partially submerged in water do not try to open. Contact authorized personnel or manufacturer for further instructions.

4. Product Information

LV52 photovoltaic energy storage system is a 48V energy storage system based on lithium-ion ferrous phosphate battery. It is equipped with a customized battery management system (BMS), which is designed for energy storage applications of household photovoltaic power generation users. In the daytime, the surplus power of photovoltaic power generation can be stored in the battery. At night or when necessary, the stored energy can be provided to the electrical equipment, it can improve the use efficiency of photovoltaic power generation, peak-load shifting, and provide emergency standby power.

4.1 Battery Module Specifications

Specifications for Battery		Note
Battery module	LV52	
Nominal capacity (Ah)	104	1C, 25±2°C
Nominal voltage (Vdc)	51.2	
Nominal energy (kWh)	5.32	
Battery voltage range (Vdc)	46.4 - 58.4	
Max. continuous discharging current (A)	100	
Max. continuous charging current (A)	50	
Recommended charging current (CC-CV) (A)	50	
Charging cut off current (constant current and constant voltage) (A)	5	
Peak charging current (5s) (A)	60	
Peak discharging current (30s) (A)	150	
Cycle life(cycles)	≥6000@25°C @90% DOD	
Storage temperature (°C)	-20 - 55	
Operating temperature range (°C)	Charge: 0 - 55 Discharge: -10 - 55	
Discharge capacity (Ah)	83.2@1C@0 ±2°C 104@1C@25 ±2°C 99.8@1C@45 ±2°C	
Energy density (Wh / kg)	≥107	
Ingress protection	IP21	
Communication	RS485/CAN	
Weight (kg)	49.5±0.5	
Dimensions (L*W*H) (mm)	620*184.5*420	
Protective class	I	

4.2 Battery Charge/Discharge Curve

Current protection			
		Trigger	Recover
Battery charge	First level over current	≥55A, Lasts 3s	≥3s: Recover
	Second level over current	≥57.5A, Lasts 4s	≥3s: Recover
	Third level over current	≥60A, Lasts 5s	≥30min: Recover
Battery discharge	First level over current	≥110A, Lasts 3s	≥3s: Recover
	Second level over current	≥115A, Lasts 4s	≥3s: Recover
	Third level over current	≥120A, Lasts 62s	≥30min: Recover
	Special discharge current protection	≥155A, Lasts 3s	≥30min: Recover

5. Product Features

5.1 Battery System Features

The batteries have been fitted with multiple protection systems to ensure the safe operation of the system. Some of the protection system includes:

- Inverter interface protection: Over voltage, over current, external short circuit, reverse polarity, ground fault, over temp, in rush current.
- Battery Protection: Internal short circuit, over voltage, over current, over temp, under voltage.

The battery system contains the following Interface to allow it to connect and operate efficiently.

Battery interface:

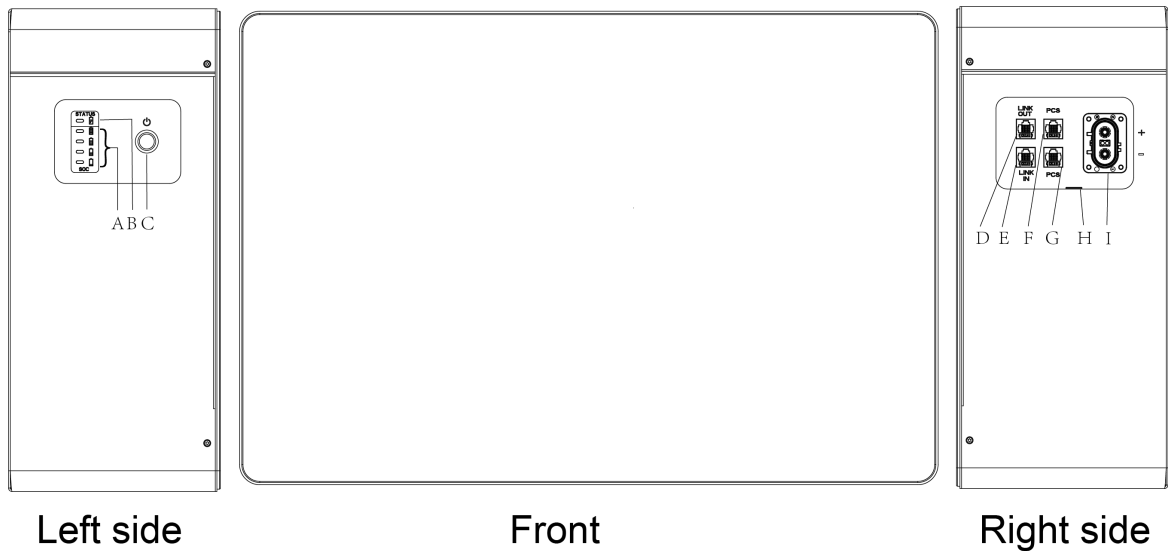

Object	Description	Object	Description
A	SOC LED	F	PCS_1
B	STATUS LED	G	PCS_2
C	POWER SWITCH	H	Ground screw
D	LINK OUT	I	POWER
E	LINK IN		

Communication parallel interface (LINK IN, LINK OUT, CAN) and communication interface to inverter (CAN/RS485)

Network interface description: LINK IN is connected to the upper battery module, LINK OUT is connected to the lower battery module. PCS is the communication interface to the inverter.

The interface is defined as follows:

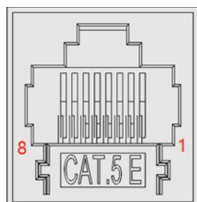

Pin configuration is as follows:

- **LINK IN**

Pin	Function definitions	Function declaration
1	Master_SL	Master_SL
2	RACK_CANL	CANL
3	RACK_CANL	CANL
4	RACK_CANH	CANH
5	RACK_CANH	CANH
6	ISO_GND	GND
7	Sync_WKEOUT	WakeUpIn
8	Encode_IN	Encode_IN

- **LINK OUT**

Pin	Function definitions	Function declaration
1	Master_SL	Master_SL
2	RACK_CANL	CANL
3	RACK_CANL	CANL
4	RACK_CANH	CANH
5	RACK_CANH	CANH
6	ISO_GND	GND
7	Sync_WKEOUT	WakeUpIn
8	Encode_IN	Encode_IN

- **PCS_1**

Pin	Function definitions	Function declaration
1	GND	GND
2	GND	GND
3	PCS_485B	RS485-B
4	PCS_CANL	CANL
5	PCS_CANH	CANH
6	PCS_WKE-	WakeUp-
7	PCS_WKE+	WakeUp+
8	PCS_485A	RS485-A

- **PCS_2**

Pin	Function definitions	Function declaration
1	GND	GND
2	GND	GND
3	PCS_485B	RS485-B
4	PCS_CANL	CANL
5	PCS_CANH	CANH
6	PCS_WKE-	WakeUp-
7	PCS_WKE+	WakeUp+
8	PCS_485A	RS485-A

Earth Terminal

This terminal is used to connect the battery to the earth for safety purposes.

Handle

The handle is used to carry or move the battery.

Power Terminal

A set of positive and negative terminals to connect the battery to the inverter. When you are unplugging the wires from the terminals, make sure you press the lock button and then pull it. When installing the plug, do not press the button and push the plug until you hear a click sound.

In addition to the above physical features, the battery has the following performance:

1. 90% Depth of Discharge;
2. Cycle life ≥ 6000 cycles.

6. Installation

6.1 Items in the package

Please check if following items are including with the package:

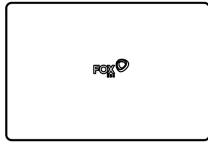

A

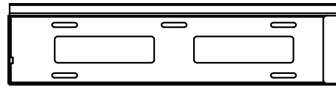

B



C



D



E

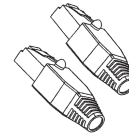

F

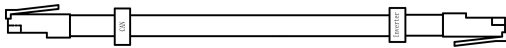

G

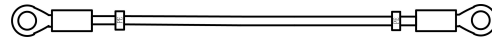

H



I

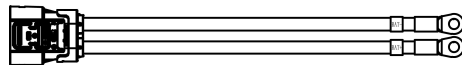

J

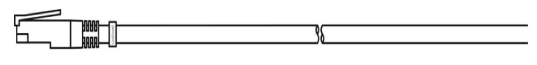

K

Object	Quantity	Description	
A	1	Battery	In the Battery Package
B	1	Bracket	
C	5+5	Expansion Tubes& Expansion Screws	
D	4	Set screw	
E	2	Earth Terminal	
F	2	Plug (to short pin1 and pin6)	
G	1	Communication Network Cable(3m)	
H	1	Ground Wire(3m)	
I	1	Quick Installation Guide	
J	1	Power Line (3m)	
K	1+1	Communication Network Cable (3m) (Inverter to Battery) (RS485&CAN)	

K : To match the different inverters, our accessory packs are differentiated, so please look at the wire markings on the white sleeves before wiring.

K-1

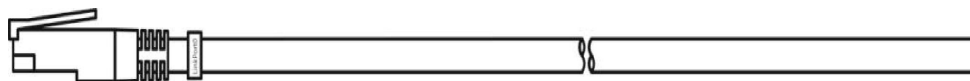

RS485 (Battery side)

RS485 (Inverter side)



Please plug into the PCS port of the battery.

Please plug into the RS485 Port of the inverter.

RS485 (Battery side) Pin definition:

Pin	1	2	3	4	5	6	7	8
Definition	NC	NC	RS485-B	NC	NC	NC	NC	RS485-A

K-2

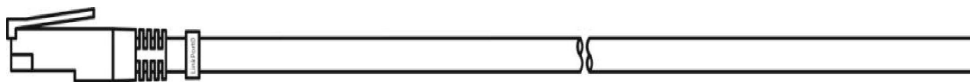

CAN (Battery side)

CAN (Inverter side)

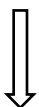

Please plug into the PCS port of the battery.

Please plug into the CAN Port of the inverter.

CAN (Battery side) Pin definition:

Pin	1	2	3	4	5	6	7	8
Definition	NC	NC	NC	CANL	CANH	NC	NC	NC

Note: The definition of the inverter side end plug needs to be crimped in accordance with the inverter's manual.

Note:

1. Use only the parts included with the battery pack to ensure proper installation. If anything is damaged or missing, please contact your distributor.
2. Select an interface (CAN/RS485) based on the actual inverter interface type.

6.2 Clearance

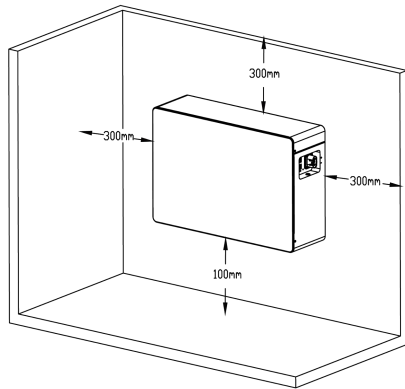

Position	Suggested size
Left	>300mm
Right	>300mm
Top	>300mm
Bottom	<100mm

Make sure to leave a space of at least 30 cm. A clearance of at least 30 cm must be left around the battery pack for proper cooling.

Note: Make sure that the battery pack is always exposed to the ambient air. The battery pack is cooled by natural convection. If the battery pack is entirely or partially covered or shielded, it may cause the battery pack to stop operating.

6.3 Tools

The following tools will be required to install the battery.



Screw driver



Crimping modular



Safety shoes



Safety gloves



Safety goggles



Plier



Spanner



Multimeter



Ribbon



Electric Drill



Track Level Bar

6.4 Installation Steps

- **Mounting**

STEP-1

Fix the pegboard on the wall and mark the position of the five holes with a marker.

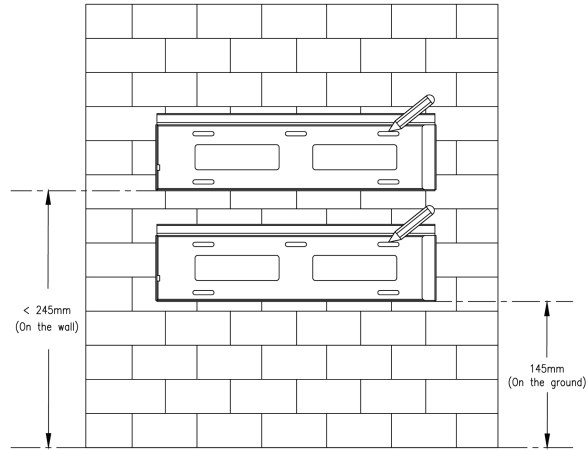

STEP-2

Drill holes with electric drill, make sure the holes are deep enough (at least 50mm) for installation, and then tighten the expansion tubes.

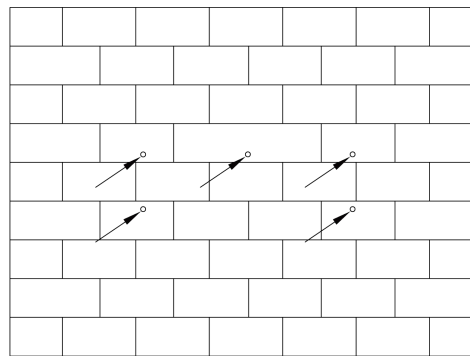

STEP-3

Install the expansion tube in the hole and fix the pegboard with self-tapping screws, then pre-lock the M5*70 screws on both sides (pre-lock depth <15mm).

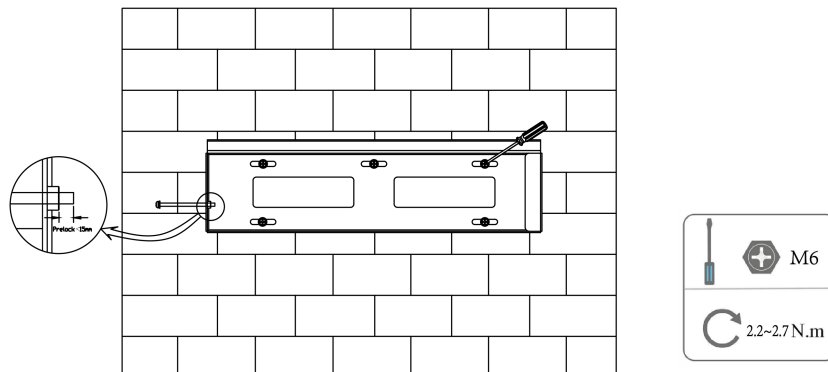

STEP 4

Hang the battery over the bracket, move the battery close to it, lower the battery, and make sure the 2 mounting bars on the back are fixed well with the 2 grooves on the bracket.

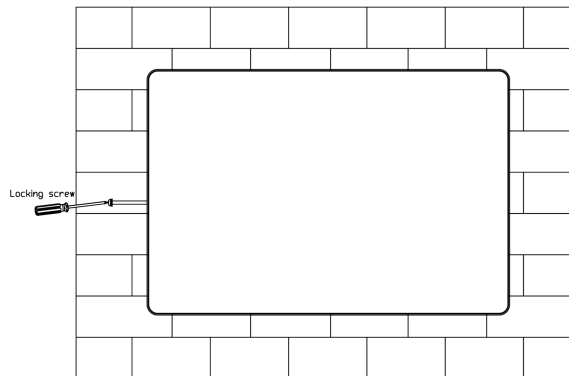

• **Wiring**

Wall mounting:

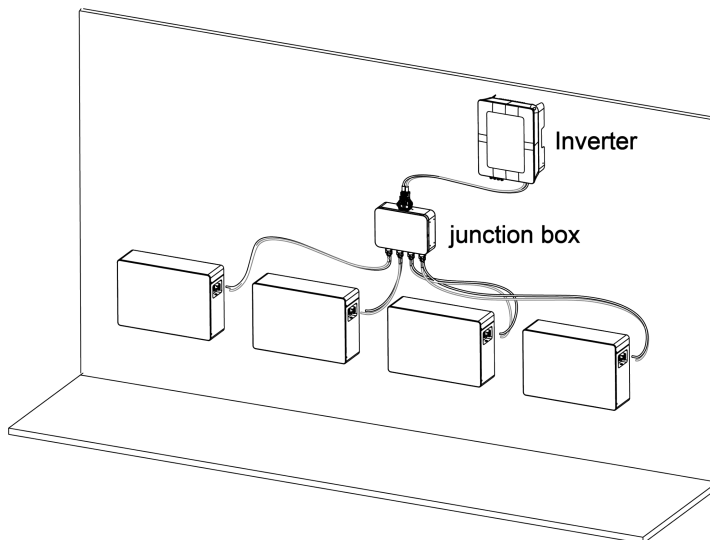

Standing mounting:

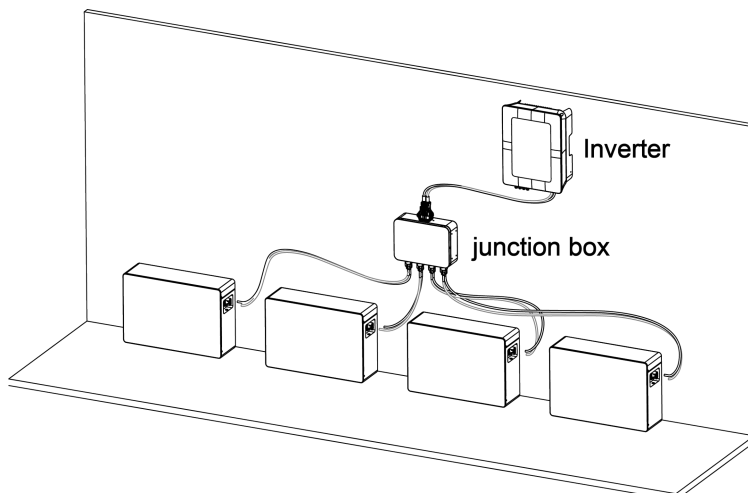

Note: junction box not included in the package and need separate purchase.

Stand-alone mode:

STEP -1:

After installing the fixed battery, measure the voltage of the positive and negative terminals of the battery with a multimeter to determine whether there is a voltage output, and if so, replace the battery.

STEP -2:

Plug the 2 plugs (to short pin1 and pin6) into the parallel communication interface LINK IN and LINK OUT of the battery respectively.

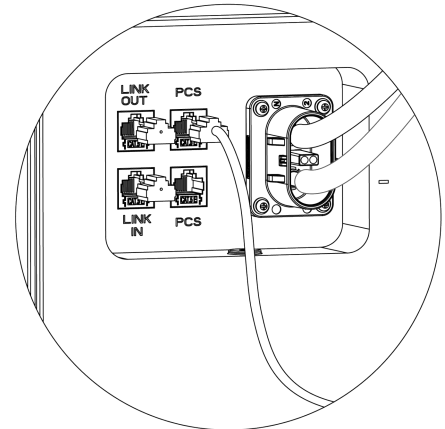

STEP -3:

Connect the BAT+ and BAT- of the battery to the corresponding positive and negative terminals of the inverter; Connect one of the communication interface PCS of the battery to the interface of the communication between the inverter and the battery; Connect the ground wire.

Parallel mode:

STEP -1:

After installing the fixed battery, measure the voltage of the positive and negative terminals of the battery with a multimeter to determine whether there is a voltage output, and if so, replace the battery.

STEP -2:

To connect the parallel communication cable between the batteries, the LINK IN of the **Master battery**, i.e. the first machine, needs to be plugged in with a plug (to short pin1 and pin6), the LINK OUT interface uses a parallel communication cable(pin to pin network cable) to the LINK IN interface of the next battery, and so on, and the last LINK OUT interface is plugged in with a plug (to short pin1 and pin6).

Note: Parallel mode supports up to 4 batteries in parallel.

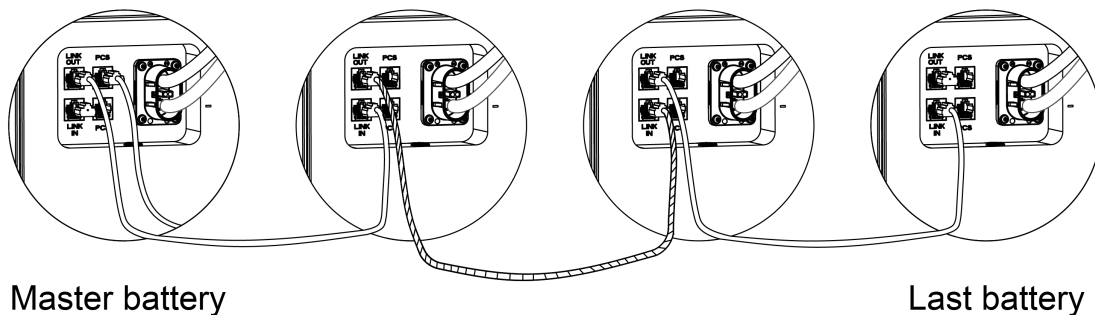

STEP -3:

Connect the BAT+ and BAT- of the battery to the input of the junction box (not included in the package), and then connect the output of the junction box to the inverter; Connect one of the communication interface PCS of the **Master battery** to the interface of the communication between the inverter and the battery; Connect the ground wire of each battery.

Note: the length of the power line needs to be the same when in parallel mode.

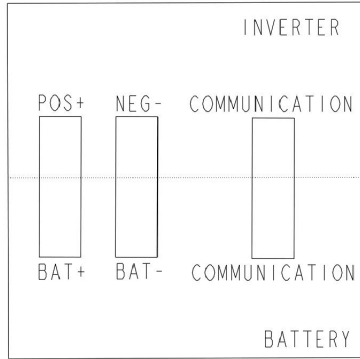

Lead-acid function:

In the above two modes, when operating according to the corresponding steps, the communication harness between the battery and the inverter is not connected, and the battery enters the lead-acid function by default; Both stand-alone mode and parallel mode have lead-acid function.

When the battery uses the lead-acid function, the matching inverter needs to be set to lead-acid mode as well, and the following parameters need to be set on the inverter:

Battery capacity (Ah)	104
Charging voltage (V)	56.0
Charging protection voltage (V)	57.6
Float voltage (V)	53.0
Maximum charging current (A)	50
Discharge cut-off voltage (V)	51.0
Maximum discharge current (A)	100
Forced charging voltage (V)	50.0
Battery internal resistance (mΩ)	15

Note: The above is a preliminary recommended value, because the power consumption strategy of the inverter of different manufacturers is different, the specific parameters need to be adjusted according to the manufacturer of the inverter.

6.5 System Start up

- When connected to the inverter, turn on the battery first to ensure that the battery voltage output is normal, then turn on the inverter.
- All installation and operation must comply with local electrical standards.
- Check all power cables and communication cables carefully.

7. Commissioning

There are seven LED indicators on the front of the battery packs to show its operating status.

Fault status indicated by indicator:

- LED flash display (on: 0.5S, off: 0.5S);
- / LED off display;
- LED on display;
- ★ LED flash display (on: 0.25S, off: 0.25S);

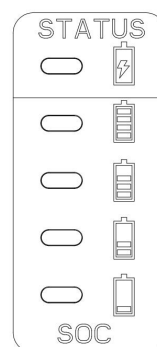

Status-led: bi-color light, SOC-led: green light

1. The RUN indicator blinks and the ALARM indicator is off: The battery is running.

LV 52 LED display logic

LV52 Condition	LED indication	Status-LED		SOC-LED (left ≤ right)				Remarks
		Green	Red	Led-4	Led-3	Led-2	Led-1	
Start		Flowing lights						Add start-up display
Shutdown		/	■	■	■	■	■	Add shutdown display
Parallel addressing success		★	/	/	/	/	/	Green light flashing 20 times
Test Mode		■	■	■	■	■	■	
Standby	Standby	■	/	/	/	/	/	
CHARGE	=100%	●	/	●	●	●	●	

	100% > SOC ≥ 75%	●	/	■	■	■	■	Flowing lights
	75% > SOC ≥ 50%	●	/	/	■	■	■	
	50% > SOC ≥ 25%	●	/	/	/	■	■	
	25% > SOC ≥ 0%	●	/	/	/	/	■	
DISCHARGE	=100%	●	/	●	●	●	●	
	100% > SOC ≥ 75%	●	/	■	■	■	■	
	75% > SOC ≥ 50%	●	/	/	■	■	■	
	50% > SOC ≥ 25%	●	/	/	/	■	■	
	25% > SOC ≥ 0%	●	/	/	/	/	■	

2. RUN indicator Steady on: The device is powered off or the battery is faulty and cannot be charged or discharged.

LV 52 LED display logic

LV52 Condition	LED indication	Status-LED		SOC-LED (left ≤ right)				Remarks
		Green	Red	Led-4	Led-3	Led-2	Led-1	
Fault	Under voltage fault	/	■	/	/	/	●	
	Over voltage fault	/	■	/	/	●	/	
	Over temperature fault	/	■	/	/	●	●	
	Under temperature fault	/	■	/	●	/	/	

Discharge over current	/	■	/	●	/	●	
Charge over current	/	■	/	●	●	/	
Discharge over power	/	■	/	●	●	●	
Charge over power	/	■	●	/	/	/	
Pre-charge failure	/	■	●	/	/	●	
Short circuit protection	/	■	●	/	●	/	
AFE communication failure	/	■	●	/	●	●	
Parallel addressing failure	/	■	●	●	/	/	
Internal communication exceptions	/	■	●	●	/	●	
Power parallel failure	/	■	●	●	●	/	
PCS communication abnormality	/	■	●	●	●	●	
FUSE failure	/	●	/	/	/	●	
Current sampling fault	/	●	/	/	●	/	
Power supply failure	/	●	/	/	●	●	
Internal total pressure sampling failure	/	●	/	●	/	/	
Temperature sampling failure	/	●	/	●	/	●	
MOS adhesion	/	●	/	●	●	/	

	MOS Not Close	/	●	/	●	●	●	
	MOS drive failure	/	●	●	/	/	/	
	Monomer "OV" failure	/	●	●	/	/	●	
	High temperature permanent failure	/	●	●	/	●	/	
	High monomer voltage permanent failure	/	●	●	/	●	●	
	SOH low protection	/	●	●	●	/	/	
	AFE Failure (UV/OV/UT/OT)	/	●	●	●	/	●	
	Charger overvoltage	/	●	●	●	●	/	
	Other fault	/	●	●	●	●	●	

8. Exclusion

The warranty shall not cover the defects caused by normal wear and tear, inadequate maintenance, handling, storage faulty repair, modifications to the battery or pack by a third party other than manufacturer or manufacturer agent, failure to observe the product specification provided herein or improper use or installation, including but not limited to the following.

- Damage during transport or storage.
- Incorrect Installation of battery into pack or maintenance.
- Use of battery pr pack in inappropriate environment.
- Improper, inadequate, or incorrect charge, discharge or production circuit other than stipulated herein.
- Incorrect use or inappropriate use.
- Insufficient ventilation.
- Ignoring applicable safety warnings and instructions.
- Altering or attempted repairs y unauthorized personnel.
- In case of force majeure (ex: lightning, storm, flood, fire, earthquake, etc.).
- There are no warranties-implied or express-other than those stipulated herein. manufacturer shall not be liable for any consequential or indirect damages arising or in connection with the product specification, battery or pack.

9. Troubleshooting and Maintenance

9.1 Maintenance

- 1) It is recommended that the battery storage time is not more than 6 months.
- 2) **It is required to charge the battery at least once every 6 months, for this charge maintenance make sure the SOC is charged to higher than 70%.**
In the condition of 90% charging. It is recommended that the customers use low-voltage inverter and fill the battery every half month, otherwise the SOC will be deviated.
- 3) Every year after installation. The connection of power connector, grounding point, power cable and screw are suggested to be checked. Make sure there is no loose, no broken, no corrosion at connection point. Check the installation environment such as dust, water, insect etc. Make sure it is suitable for IP21 battery system.

9.2 Troubleshooting

When the red / green LED on the panel is flashing or normally on, it does not mean that the LV is abnormal, it may be just an alarm or protection. Please check the 'LED status indicators' in chapter 7 for the detailed faulty definition before any trouble-shooting steps. In general, the alarm indication is normal without manual intervention. When the alarm triggering state is removed, LV52 will automatically return to normal use.

- Problem determination based on the following points

- 1) Whether the green light on the power switch is on;
- 2) Whether the buzzer in BMS is on;
- 3) Whether the battery system can be communicated with inverter;
- 4) Whether the battery can be output voltage or not.

- Preliminary determination steps

- 1) Battery system cannot work, when DC switch on, the LED doesn't light up or flash, please consider contact the local distributor.
- 2) The LED display of BMS is normal, but it cannot charge and discharge. Observe the display screen of inverter and there is no SOC. Please check whether the communication between BMS to inverter is well connected. If the connection is good, please replace communication cable. If the SOC is still not visible on the inverter display screen, please contact the local distributor.
- 3) After the battery system is powered on, if you can see the alarm information on the LED and inverter display screen at the same time, please contact the local distributor.

Note: Under the lead-acid function, the battery does not communicate with the inverter, and the inverter will not display the SOC information of the battery.

