



INVERTER

Installation and operating instructions

AX series, 1ph



INTRODUCTION

The publication and copyright of this documentation remain with the company:

AKKU SYS Accumulator and Battery Technology Nord GmbH

Connection path 23 D-25469 Halstenbek · GERMANY

Telephone +49 4101 37676-0 · Fax +49 4101 85475-66

info@akkusys.de · www.akkusys.de · akkusys.shop

Read carefully before use!

Read this instruction manual carefully before installation.

It contains important regulations and information for the use of this product and provides technical support for the operator of the device.

All rights reserved.

AKKU SYS Akkumulator- und Batterietechnik Nord GmbH cannot be held responsible for any inaccuracies or inappropriate information in these operating instructions. The information in this document can be read without
may be changed with prior notice, but there is no obligation to continually update it.

Design and equipment changes that improve the production process
or the product are reserved.

Our EU declaration of conformity and warranty conditions can be found on:

www.a-tronix.de

Table of contents

	Page
1. Notes about this manual	4
1.1 Scope	4
1.2 Target group	4
1.3 Symbols used	4
2. Security	5
2.1 Intended use	5
2.2 PE connection and leakage current	6
2.3 Surge Protection Devices (SPDs) for PV Installation	8th
Introduction	9
3.1 Basic Features	9
3.2 Dimensions	10
3.3 Inverter terminals	11

4. Technical data	12
4.1 PV input (only for hybrid)	12
4.2 Battery	12
4.3 AC Output/Input	13
4.4 EPS	13
4.5 Efficiency	14
4.6 General data	14
5. Installation	15
5.1 Check for physical damage	16
5.2 Packing list	16
5.3 Assembly	17
6. Electrical connection	20
6.1 PV connection (only for hybrid)	20
6.2 Connecting the battery	22
6.3 AC connection	23
6.4 Ground connection	26
6.5 Installation of a communication device (Optional)	26
6.6 EPS connection	33
6.7 System connection diagrams	35
6.8 Commission the inverter	36
6.9 Switch off the inverter	36
7. Operation	37
7.1 Control panel	37
7.2 Function tree	38
8. Maintenance	39
8.1 Overview of error codes	39
8.2 Troubleshooting and routine maintenance	44
9. Decommissioning	45
9.1 Dismantling the inverter	45
9.2 Packaging	45
9.3 Storage and transportation	45

1. Notes about this manual

1.1 Scope

This manual describes the assembly, installation, commissioning, maintenance and troubleshooting for the following models of the a-TroniX products:

AX3.0kW-1ph, AX3.7kW-1ph, AX4.6kW-1ph, AX5.0kW-1ph, AX6.0kW-1ph



A NOTICE

Please keep these instructions so that they are accessible at all times.

1.2 Target group

This manual is intended for qualified electricians. All tasks described may only be carried out by a qualified electrician be performed.

1.3 Symbols used

The following types of safety warnings and general information appear in this document as described below:



DANGER!

WARNING!

CAUTION!

This symbol indicates a hazardous situation which, if not avoided, could result in serious injury or death.



A NOTICE:

This symbol indicates texts, hints or tips.

Failure to take preventative protective measures could potentially result in damage to the product and/or its functions or to something in its surroundings.

This section explains the symbols that appear on the inverter and on the Type plate shown are:



The inverter complies with the requirements of the applicable CE guidelines.



Be careful of hot surfaces. The inverter can become hot during operation. Avoid touching during operation.



Danger due to high voltages.
Danger to life due to high voltages in the inverter!



Danger.
Danger of electric shock!



Danger to life due to high voltages.
There is a residual voltage in the inverter that takes 5 minutes to discharge.
Wait 5 minutes before opening the top lid or the DC lid.



Read the manual.



The product must not be disposed of as household waste.



Protective conductor connection

2. Security

2.1 Intended use

The inverters of the a-TroniX series AX were developed and tested in accordance with international safety requirements. However, certain safety precautions must be taken when installing and operating this inverter. The installer must read and follow all instructions, safety notices and warnings in this installation manual.

- All work, including transport, installation, commissioning and maintenance, must be carried out by qualified, trained personnel.
- The electrical installation and maintenance of the inverter must be carried out by a qualified electrician and in accordance with local regulations and comply with regulations.
- Check the device before installation to ensure there are no transport damage that could affect the integrity of the insulation or the safety distances. Choose the installation location carefully and comply with prescribed cooling requirements. Unauthorized removal of necessary protective devices, improper use, incorrect installation and operation may result in serious safety hazards, electric shock hazards, or equipment damage.
- Consult before connecting the inverter to the power grid the local network operator to obtain the appropriate permits. This connection may only be made by qualified specialist personnel.

- Do not install the device in unfavorable environmental conditions, such as e.g. B. in the immediate vicinity of flammable or explosive substances, in a corrosive or desert-like environment, at extremely high or low temperatures or in high humidity.
- Do not use the device if the safety devices are not working.
kidney or are deactivated.
- Use personal protective equipment during installation, including Gloves and eye protection.
- Inform the manufacturer of any non-standard installation conditions.
- Do not use the device if abnormalities are detected. Avoid Make temporary repairs.
- Only approved spare parts may be used for all repairs according to their intended use and by a licensed professional or an authorized AKKU SYS service representative.
- Liability for commercially available components lies with the respective manufacturer delegated.
- Whenever the inverter has been disconnected from the public grid, leave Please use extreme caution as some components may retain sufficient charge to create a risk of electric shock. Before touching any part of the inverter, please make sure that the surfaces and devices are free of dirt high temperatures or voltage potentials before proceeding.

2.2 PE connection and leakage current

The residual current factors of PV systems

- In every PV system, several elements contribute to the leakage current to protective earth (PE). These elements can be divided into two main types.
- **Capacitive leakage current:** The leakage current is mainly caused by the parasitic Capacity of the PV modules compared to PE. The module type, the environmental conditions (rain, humidity) and even the distance of the modules from the roof can influence the discharge current. Other factors contributing to parasitic The capacity that can contribute is the internal capacity of the inverter compared to PE and external protective elements such as the lightning protection.
- During operation, the DC bus is connected to the AC network via the inverter. As a result, part of the alternating voltage amplitude reaches the intermediate circuit. The fluctuating tension is constantly changing the state of charge of the parasitic PV capacitor (i.e. capacity to PE). This is associated with a displacement current that is proportional to the capacity and the applied voltage amplitude.
- **Residual current:** In the event of an error, e.g. B. a defective insulation, where an under A live cable that comes into contact with a grounded person will flow an additional current called residual current.

Residual current device (RCD)

- All a-TroniX inverters are equipped with a certified internal residual current

protective device (RCD) that protects against a possible malfunction in the event of a malfunction of the PV generator, cables or inverter (DC).

Protects against electric shock. The residual current protection device in the a-TroniX inverter can detect leaks on the DC side. There are 2 trigger thresholds for the FI circuit breaker, as required in the DIN VDE 0126-1-1 standard. A low one Threshold serves to protect against rapid changes in leakage, as in occur when people come into direct contact. A higher threshold is used for slowly increasing leakage currents to reduce the current in grounding conductors to limit security. The default value for higher speed personal protection is 30mA and lower for fire protection
Speed 300mA per unit.

Installing and selecting an external RCD circuit breaker

- In some countries an external RCD circuit breaker is required. The installer must check which type of RCD circuit breaker is available in the respective local area regulations are required. The installation of an RCD circuit breaker must always be carried out in accordance with local regulations and standards. a-TroniX recommends using a type A RCD circuit breaker. a-TroniX recommends an RCD circuit breaker with a value between 100mA and 300mA, unless local regulations require a lower value.
- Installations where local electrical codes require an RCD circuit breaker with a lower leakage current rating may result in the external RCD circuit breaker being accidentally tripped due to the discharge current. The following steps are recommended to avoid unwanted tripping of the external RCD circuit breaker:
 1. Selecting a suitable RCD circuit breaker is important for the correct operation of the system. An RCD circuit breaker rated at 30mA can trigger with a leakage current of 15mA (according to IEC 61008). High-quality RCD circuit breakers usually trip at a value that is closer to its nominal value.
 2. Configure the trip current of the internal RCD circuit breaker
Inverter to a lower value than the tripping current of the external RCD circuit breaker. The internal RCD circuit breaker trips when the
Current exceeds the permissible value. Because the internal RCD circuit breaker
However, the inverter automatically resets when the fault currents
are low, manual reset can be saved.

2.3 Surge protection devices (SPDs) for PV installation



WARNING!

When installing the PV system, surge protection with surge arresters should be provided. The grid-connected inverter is not equipped with SPDs on either the PV input side or the grid side.

Lightning causes damage either from a direct strike or from surges due to a nearby strike.

Induced surges are the most likely cause of lightning damage in the majority of installations, particularly in rural areas where power is typically supplied via long overhead power lines. Surges can affect both the PV generator line and the AC cables leading to the building. Lightning protection professionals should be consulted for final application. With suitable external lightning protection, the impact of a direct lightning strike on a building can be weakened in a controlled manner and the lightning current can be diverted into the ground.

The installation of SPDs to protect the inverter from mechanical damage and excessive stress includes a surge arrester in the case of a building with an external lightning protection system (LPS) when a separation distance is maintained. To protect the DC system, a surge protection device (SPD Type2) should be installed at the end of the DC wiring of the inverter and on the array between the inverter and the PV generator when the voltage protection level (VP) of the surge arresters is greater than 1100V, an additional SPD type 3 is required for overvoltage protection for electrical devices.

To protect the AC system, surge protective devices (SPD Type2) should be installed at the main input point of the AC supply (at the load cutout), which is located between the inverter and the meter/distribution system; SPD (test pulse D1) for signal line according to EN 61632-1. All DC lines should be laid as short as possible; plus and minus lines of the string or the main DC supply should be bundled.

The formation of loops in the system must be avoided. This short routing and bundling requirement includes all associated ground bundling conductors.

Spark gap devices are not suitable for use in DC circuits once they are conductive; they only stop conducting when the voltage across their terminals is typically below 30 volts.

3. Introduction

3.1 Basic properties

The high-quality inverters of the AX series are used to convert solar energy into alternating current and store energy in the battery. The inverter can be used to optimize self-consumption, to store in the battery for later use or to feed into the public grid. The working mode depends on the PV energy and user's preferences.

System advantages:

- Advanced DSP control technology.
- Uses the latest high-efficiency power component.
- Advanced anti-islanding solutions.
- Protection class IP65.
- Max. efficiency up to 97.8%. EU efficiency up to 97.0%. THD <3%.
- Safety & Reliability:
Transformerless design with software and hardware protection.
- Export limitation (CT/Meter/DRM0/ESTOP).
- Power factor control. User-friendly HMI.
- LED status indicators.
- LCD display technical data, human-machine interaction through four Touch buttons.
- PC remote control.

Working mode

Working mode description	
Own consumption (with PV power)	Priority: Load > Battery > Grid The energy generated by the PV system is used to optimize self-consumption. The excess energy is used to charge the batteries and then exported to the grid.
Own consumption (without PV power)	If there is no PV feed-in, the battery first discharges for local loads. The battery is charged when an excess of electricity from other generation sources is detected.
feed-in priority	Priority: Load > Grid > Battery In the case of the external generator, the electricity generated is first used to supply local consumers and then fed into the public grid. The battery is charged with the redundant current.
time use force	Priority: Battery > Load > Mains (when charging) Priority: Load > Battery > Mains (when discharging) This mode applies to the area in which the electricity price lies between peak and trough. The user can use off-peak power to charge the battery. The charging and discharging time can be set flexibly, and you can also choose whether to charge from the mains or not.
Backup mode	When the grid is off, the system supplies emergency power from the PV system or battery to power the loads in the house (the battery is required in EPS mode).

3.2 Dimensions

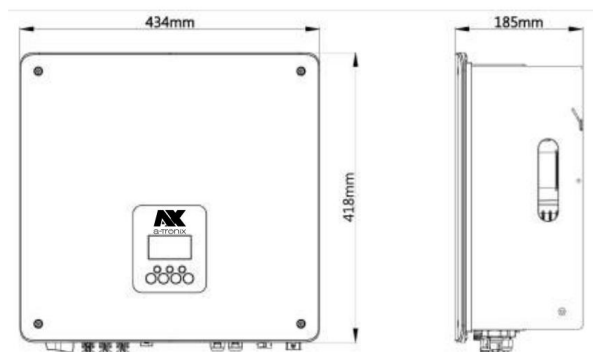

3.3 Inverter terminals

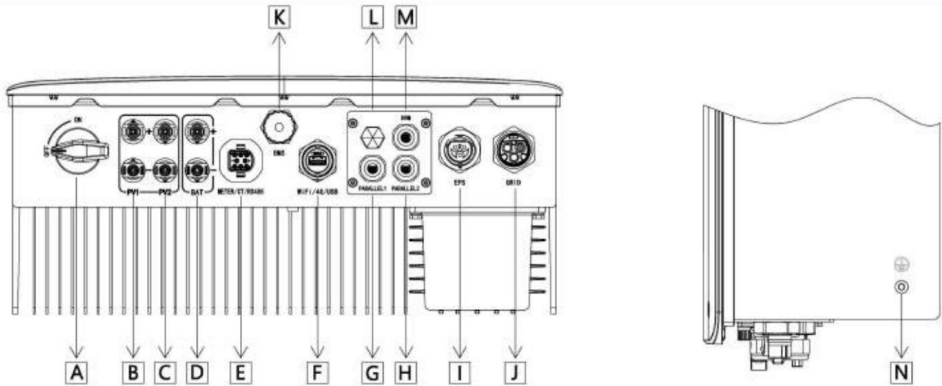

Article	Description
A	DC switch (only for hybrid)
b	PV1 (Only for Hybrid)
C	PV2 (Only for Hybrid)
D	Battery connections
E	Measuring device / CT / RS485
F	WiFi/4G/USB
G	PARALLEL 1
H	PARALLEL 2
I	EPS
J	GRID
K	BMS
L	Waterproof lock valve
M	DRM
N	Grounding screw



A NOTICE:

Only authorized personnel are allowed to establish the connection.

4. Technical data

4.1 PV input (only for hybrid)

Model AX, 1ph	3kW	3.7kW	4.6kW	5kW	6kW
PV					
Max. recommended DC power [W]	4500 A:2250 B:2250	5500 A:2750 B:2750	6900 A:3450 B:3450	7500 A:3750 B:3750	9000 A:4500 B:4500
Max. DC voltage [V]	600				
Nominal DC operating voltage [V]	360				
Max. input current (input A / input B) [A]	16/16				
Max. short-circuit current (input A / input B) [A]	20/20				
Max. regenerative current of the inverter to array [mA]	0				
MPPT voltage range [V]	80-550				
Switch-on voltage [V]	100				
Number of MPP trackers	2				
Strings per MPP tracker	1				
DC switch	Optional				

4.2 Battery

Model AX, 1ph	3kW	3.7kW	4.6kW	5kW	6kW
battery					
Battery type	LFP				
Battery voltage range [V]	80-480				
Recommended battery voltage [V]	300Vdc				
Max. charging current [A]	40				
Max. discharge current [A]	40				
Communication interfaces	CAN/RS485				
Reverse polarity protection	Yes				
Operating temperature [°C]	-10 ~ +50				
Storage temperature [°C]	-20 ~ +50				

4.3 AC output/input

Model AX, 1ph	3kW	3.7kW	4.6kW	5kW	6kW
AC OUTPUT					
AC rated power [VA]	3000	3680	4600	5000	6000
Max. AC apparent power [VA]	3300	4048	4600	5500	6600
Nominal mains voltage (AC voltage range) [V]	220 / 230 / 240 (180 to 270)				
Nominal mains frequency [Hz]	50 / 60, ±5				
AC rated current [A]	13.6	16.7	20.9	22.7	27.3
Max. AC current [A]	15.0	18.4	23.0	25.0	30
AC inrush current [A]	9.6A@50us				
Max. output residual current [A]	130A@ 10us				
Maximum Output overcurrent protection [A]	35	36.7	45.8	47.7	57.4
Displacement power factor	0.8 leading to 0.8 lagging				
Total harmonic distortion (THDi, nominal power)	<3%@ rated power				
AC INPUT					
Max. AC power [VA]	6000	7680	9200	10000	12000
Max. AC current [A]	27.3	34.9	41.8	45.5	54.5

4.4 EPS output

Model AX, 1ph	3kW	3.7kW	4.6kW	5kW	6kW
EPS OUTPUT (WITH BATTERY)					
Max. EPS power [VA]	3000	3680	4600	5000	6000
EPS nominal voltage [V], frequency [Hz]	220/230/240VAC, 50/60				
EPS peak power (60s) [W]	3600	4400	5500	6000	7200
Max. EPS current [A]	13.6	16.7	20.9	22.7	27.3
Switching time [s]	<20ms				
Total harmonic distortion (THDv, linear load)	<2%@ rated power				

4.5 Efficiency and Protection

Model AX, 1ph	3kW	3.7kW	4.6kW	5kW	6kW
EFFICIENCY					
MPPT efficiency	99.90%				
Euro efficiency	95.26%	95.70%	96.23%	96.30%	96.33%
MPPT efficiency	97.01%	97.08%	97.04%	97.08%	97.08%
Max. battery charging power (PV to BAT) (@full load)	98.50%				
Max. Battery Discharge Power (BAT to AC) (@Full Load)	97.00%				
Standby consumption [W]	<10				
DEFAULT					
Security	EN 62109-1/ EN 62109-2				
EMC	IEC EN 61000-6-1/ IEC EN 61000-6-2/ IEC EN 61000-6-3/IEC EN 61000-6-4				
Certification	G99 / EN50549-1 / CEI 0-21 / VDE-AR-N 4105 and so on				

4.6 General data

Model AX, 1ph	3kW	3.7kW	4.6kW	5kW	6kW
MEASURES AND WEIGHT					
Dimensions (W x H x D) [mm]	434*418*185				
Net weight [kg]	22				
Cooling concept Art	Naturally				
Inverter topology	Not isolated				
communication	WLAN / LAN / 4G /GPRS (optional), DRM, USB, CT				
LCD display	LCD, app, website				
AMBIENT LIMIT					
Ingress protection	IP65 (for outdoor use)				
Protection class	I				
Operating temperature range d. Inverter [°C]	-25 ~ +60 (derating at +45°C)				
Humidity [%]	0% ~ 100 (non-condensing)				
Altitude [m]	<2000				
Storage temperature [°C]	-40 ~ +70				
Noise emission (typical) [dB] Overvoltage	<35				
category	III (AC), II (DC)				

5. Installation

5.1 Check for physical damage

Make sure that the inverter was undamaged during transport.

If there is visible damage, such as: B. Cracks, please contact your dealer immediately.

5.2 Packing list

Open the package and take out the product, please check the accessories first. The packing list is shown below.

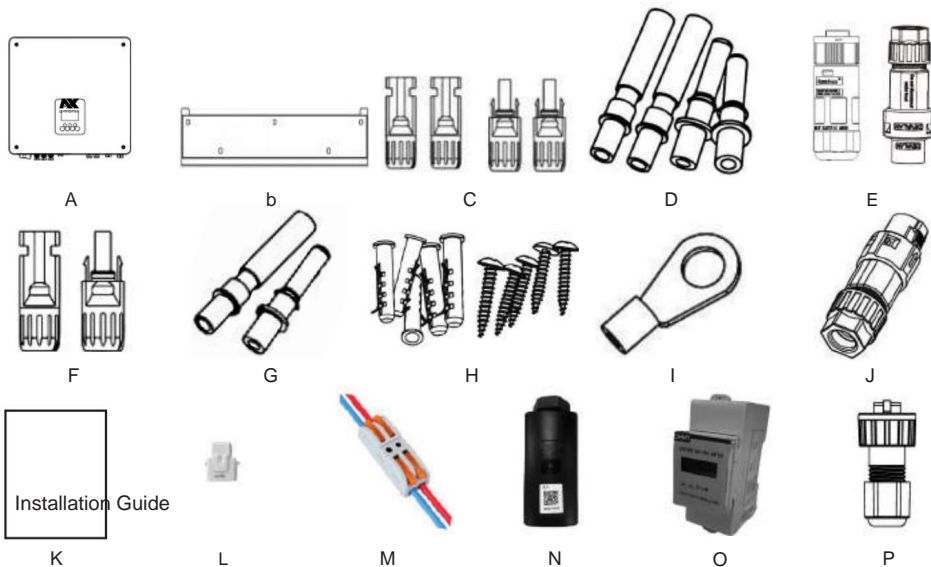

Object	quantity	description	Object	quantity	description
A	1	Inverter	I	1	Ground connection
b	1	Brackets	J	1	Communication port
C	4	PV connections (only for hybrid) (2*positive, 2*negative)	K	1	Quick installation guide
D	4	PV pin contacts (only for hybrid) (2*positive, 2*negative)	L	1	CT (with 10m cable)
E	2	AC connections	M	1	CT extension plug
F	2	Battery connections (1*positive, 1*negative)	N	1	WLAN / LAN / 4G (Optional)
G	2	Battery pin contacts (1*positive, 1*negative) O		1	Measuring device (optional)
H	5	Expansion tubes & expansion screws	P	1	RJ45



A NOTICE:

Only use the components included in the scope of delivery Installation.

5.3 Assembly

Installation precautions

Make sure the installation location meets the following conditions:

- Not in direct sunlight
- Not in areas where highly flammable materials are stored
- Not in potentially explosive areas
- Not directly in cool air
- Away from the TV antenna or antenna cable
- Not higher than approx. 2000m above sea level
- Not in an environment with precipitation or high humidity (>95%)
- Under good ventilation conditions
- The ambient temperature ranges from -25°C to +60°C.
- The slope of the wall should be within +5*
- The wall on which the inverter hangs should meet the following conditions:
 - A. Solid brick/concrete or equivalent mounting surface;
 - B. The inverter needs to be supported or reinforced if the strength of the wall is not enough (e.g. wooden wall, wall covered with a thick decorative layer).

Please avoid direct sunlight, rain and snow during installation and operation.

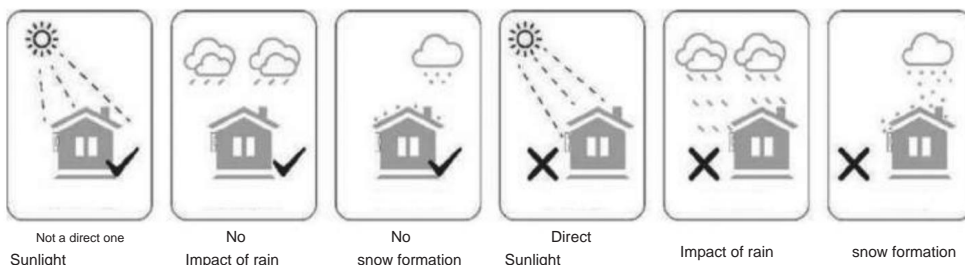

Space requirements

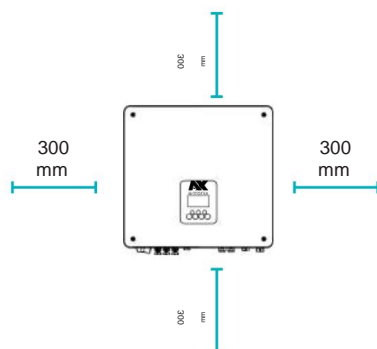

position	Minimum distance
Left	300mm
Right	300mm
Above	300mm
Below	300mm
front	300mm

Assembly steps

Tools required for installation: • Hand screwdriver; • Electric drill (8mm drill set); • Crimping pliers; wire stripper; Screwdriver.

Installation angle requirements: • Do not tilt the energy storage unit forward, horizontally, upside down, backwards or sideways.

Installation space requirements: • When installing the energy storage device, ensure that there are no other devices, flammable and explosive materials nearby, and reserve enough space to meet the heat dissipation and safety insulation requirements of the installation fulfill. • When mounting on the wall, no objects may be placed under the energy storage unit.
be provided.



Step 1. Attach the bracket to the wall • Select the location where you want to install the inverter. Attach the bracket to the wall and mark the position of the 5 holes in the bracket.

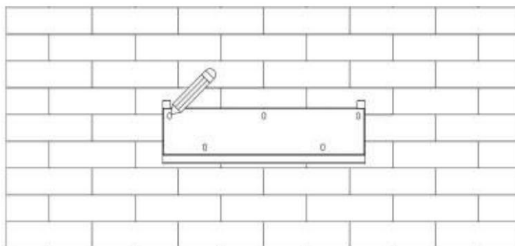

- Drill the holes with an electric drill, make sure the holes are at least 50mm deep, and then tighten the expansion tubes.

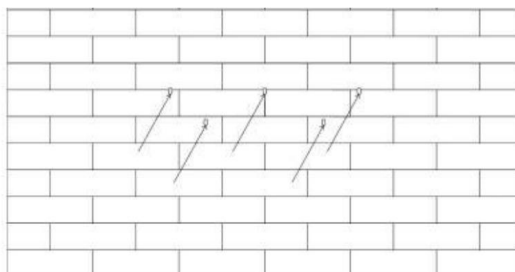

- Insert the dowels into the holes and tighten them.

Assemble the bracket with the screws.

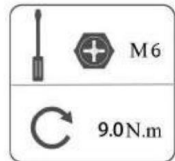
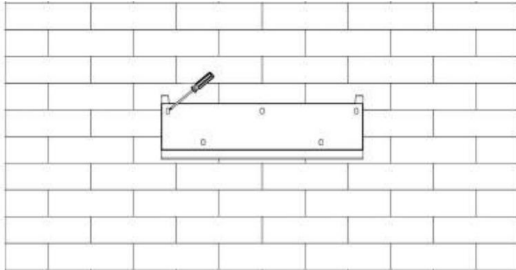

- 2. Adjusting the inverter to the wall mount** • Hang the inverter over the mount, lower the inverter slightly and make sure that the 2 mounting rods on the back are properly secured in the 2 grooves of the mount.

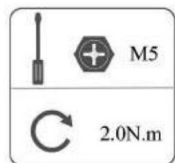
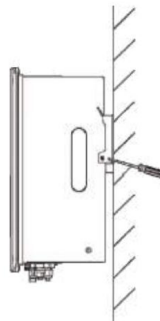
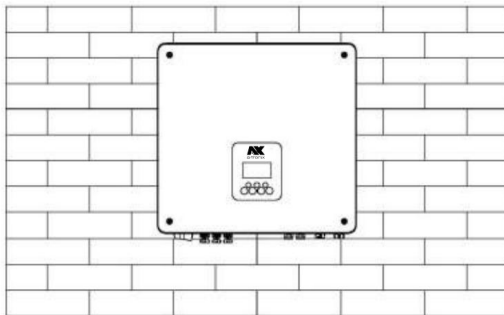

6. Electrical connection

6.1 PV connection (only for hybrid)

Step 1: PV string connection

The AX 1ph series inverters can be connected to 2 strings of PV modules. Please choose suitable PV modules with high reliability and quality. The open circuit voltage of the connected module array should be less than 600V, and the operating voltage should be within the MPPT voltage range.



A NOTICE

Please choose a suitable external DC switch if the inverter does not have a built-in DC switch.



WARNING

- The voltage of the PV modules is very high and is in a dangerous voltage range. Please observe the electrical safety rules when connecting.



- Please do not connect PV positive or negative to ground!



NOTE PV

modules:

Please ensure that they are of the same type, have the same performance and specifications, are oriented identically and are tilted at the same angle. To save cables and reduce DC losses, we recommend installing the inverter as close to the PV modules as possible.

Hinweis!

PV-Anschlussmodus unten ist NICHT erlaubt!

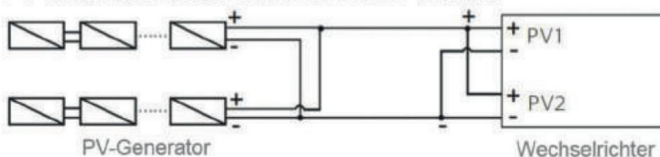

PV-Anschlussart unten ist erlaubt!

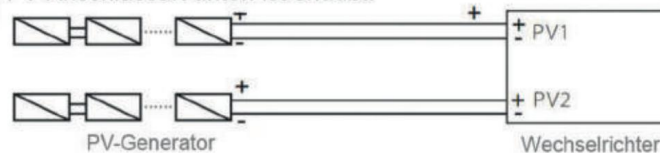

Step 2: PV Wiring

- Turn off the DC switch.
- Select 12 AWG wire for connecting the PV module.
- Cut 6mm of insulation from the end of the wire.



- Disconnect the DC connector (PV) as shown below.

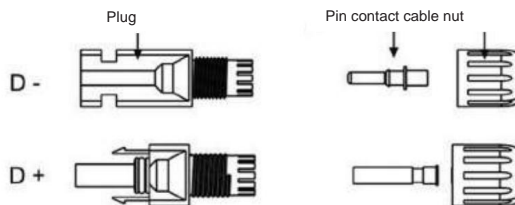

- Insert the stripped cable into the pin contact and make sure that all conductor strands are captured in the pin contact.

- Crimp the pin contact using crimping pliers. Insert the pin contact with the stripped cable into the corresponding crimping pliers and crimp the contact.

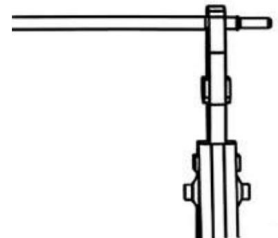

- Pass the pin contact through the cable nut and mount it on the back of the plug or socket. If you feel or hear a “click,” the pin contact assembly is properly seated.

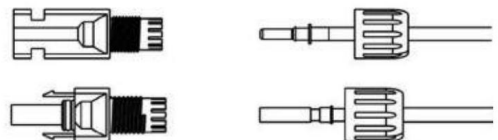

- Unlock the DC plug
 - Use the specified wrench tool.
 - When disconnecting the DC+ connector, press the tool from top to bottom.
 - When disconnecting the DC- connector, press the tool from the bottom down.
 - Disconnect the plugs by hand.

6.2 Connecting the battery

- Turn off the DC switch.
- Choose 8 AWG wire for connecting the battery.
- Cut 6mm of insulation from the end of the wire.

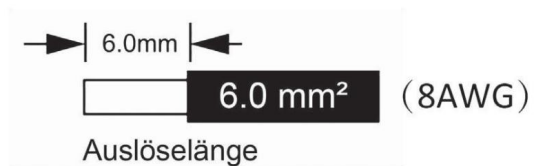

- Disconnect the DC connector (battery) as shown below.

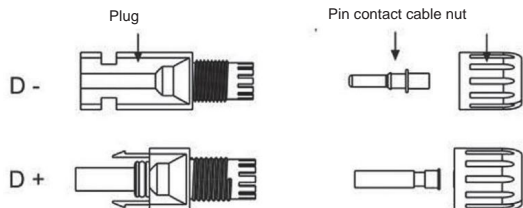

- Insert the stripped cable into the pin contact and make sure that all conductor strands are captured in the pin contact.

- Crimp the pin contact using crimping pliers. Insert the pin contact with the stripped cable into the corresponding crimping pliers and crimp the contact.

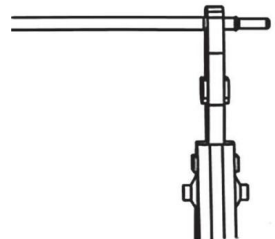

- Insert the pin contact through the cable nut and mount it on the back of the plug or socket. If you feel or hear a "click," the pin contact assembly is properly seated.

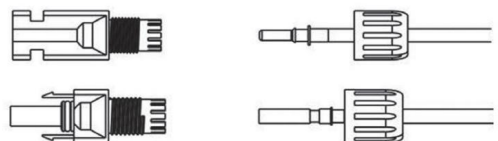

- Unlock the DC connector - Use the specified wrench tool.
 - When disconnecting the DC+ connector, press the tool from top to bottom.
 - When disconnecting the DC connector, press the tool from the bottom down.
 - Disconnect the plugs by hand.

6.3 AC connection

Step 1: AC string connection

The AX1ph series inverters are designed for single-phase networks.

The voltage range is 220/230/240V; the frequency is 50/60Hz.

Other technical requirements should comply with the requirements of the local public network.

Table 1: Without EPS function (internal)

Model (kW)	3.0	3.7	4.6	5.0	6.0
Cable (mains connected) (mm ²)	4.0		6.0		
Cable (EPS) (mm ²)	4.0		6.0		
Micro-breaker (A)	25		32		40

Table 2: With EPS function (internal)

Model (kW)	3.0	3.7	4.6	5.0	6.0
Cable (mains connected) (mm ²)	8.0-10.0				
Cable (EPS) (mm ²)	4.0		6.0		
Micro-breaker (A)	50		63		



A NOTICE:

1. If you do not use the EPS function, the core area may change the wiring refer to the parameters in Table 1.
2. If you use the EPS function, the wiring line core section can refer to the parameters of Table 2.
3. A micro switch for maximum output overcurrent protection must be used be installed between the inverter and the grid, and the current of the Protection device is shown in the table above.

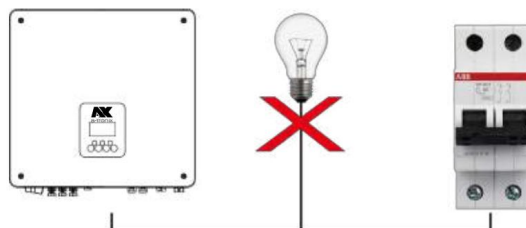

Step 2: Power Wiring

- Check the mains voltage and compare it with the permissible voltage range (see technical data).
- Switch off the circuit breaker from all phases and secure it against being switched on again.
- Shorten the wires:
 - Shorten all wires to 52.5mm and the PE conductor to 55mm.
 - Use the crimping pliers to cut 12mm of insulation from all wire ends as shown below.

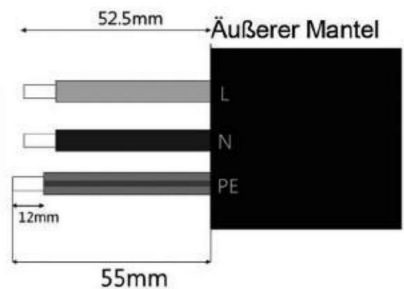

L: Brown/Red wire

N: Blue/Black Wire

PE: Yellow and green wire



A NOTICE

Please note the local cable type and color for actual installation.

A. EPS wiring

- Insert the cable into the sleeve assembly.
- Install the cable into the plug-in terminal and secure the screw, the torque is (0.8+/-0.1N m).

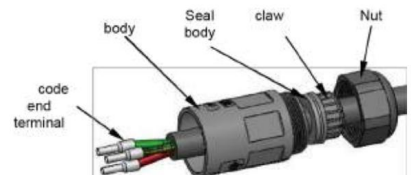
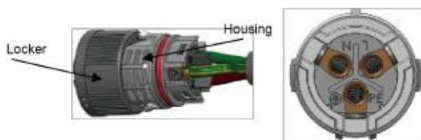

- Insert the plastic core into the main body.
- Place the seal body and the insert the thread catcher into the main housing, screw the lock nut into that main body, and the torque is (2.5+/-0.5N·m).



Operating instructions a-TroniX inverter AX series, 1ph



- Insert the male end into the female end. For the direction of rotation of the lock, please note the LOCK marking on the assembly.



- Press the threaded sleeve onto the connecting terminal until both are firmly attached. Inverters are engaged.



B. Network cabling

- Separate the mains connected plug into three parts as shown below.
 - Hold the middle part of the socket insert, turn the rear one cup to loosen it and remove it from the socket insert.
 - Remove the cable nut (with rubber insert) from the rear shell.

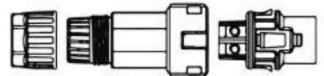

- Slide the cable nut and then the back shell onto the cable.

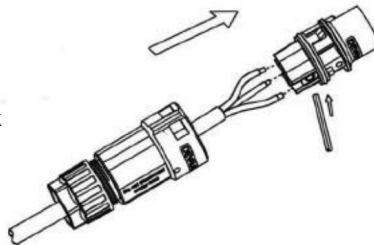

- Press the threaded sleeve into the socket, tighten the cap on the clamp.

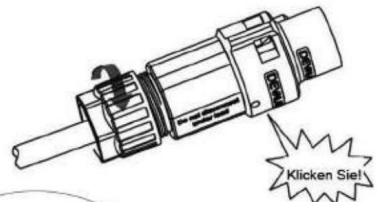

- Press the threaded sleeve onto the connection terminal until both are firmly locked onto the inverter.

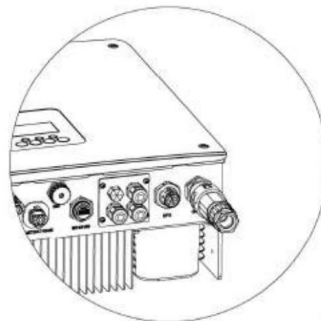

- Remove the AC connectors:
Use a small screwdriver or the release tool to push the bayonet out of the slot and pull it out, or unscrew the threaded sleeve and then pull it out.

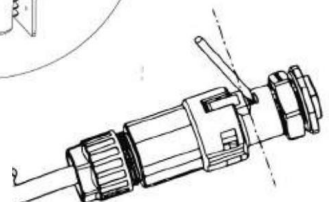

6.4 Ground connection

Use a screwdriver to screw in the ground screw as shown below:



6.5 Electrical connection

A. Installing a communication device (Optional)

The AX1ph series inverters are available with multiple communication options such as WiFi, LAN, GPRS, RS485 and meter with an external device.

Operational information such as output voltage, current, frequency, error information, etc. can be monitored locally or remotely via these interfaces.

• WLAN/LAN/4G (Optional)

The inverter has an interface for WiFi/LAN/4G devices, which allows this device to collect information from the inverter; including the inverter working status, power, etc., and update this information on the monitoring platform (the WiFi/

LAN/4G device can be purchased from your local supplier).

Connection steps:

1. **For LAN device:** Complete the cabling between the router and LAN device (refer to the LAN product manual for more information).
2. Plug the WLAN/LAN/4G device into the “WLAN/GPRS” port on the Bottom of the inverter.
3. **For WiFi device:** Connect the WiFi device to the local router and complete the WiFi configuration (see the for more details WLAN product manual).
4. Set up the location account on the a-TroniX monitoring platform (please refer to the monitoring user manual for further details).

Operating instructions a-TroniX inverter AX series, 1ph



• Measuring device /CT/ RS485

The inverter has an integrated export limitation function. To use this feature, a power meter or current transformer must be installed.

The meter/CT/485 PIN definitions Interface are as follows.

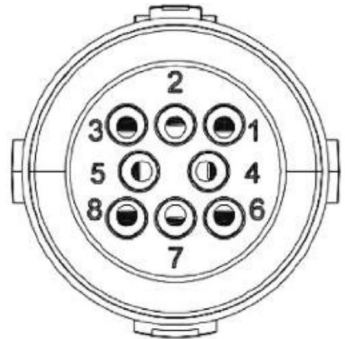

pin code	1	2	3	4	5	6	7	8th
definition	measuring device 485A	measuring device 485B	485B	485A	CT2+	CT2-	CT1-	CT1+



A NOTICE

- CT1: For Hybrid/AC.
- CT2: Grid-tied inverter (if present).
- Compatible meter type: DDSU666 (CHINT), SDM230 (EASTRON).

CT:

This inverter has an integrated export management function.

To activate this feature, a power meter or CT must be installed. The CT should be clamped to the main power line on the mains side. The arrow on the CT should point in the direction of the mesh. The white cable is connected to CT+ and the black cable to CT-.

Measuring device/CT setting:

Short press the touch button to switch the display or make the number +1. Long press the sensor button to confirm your setting.

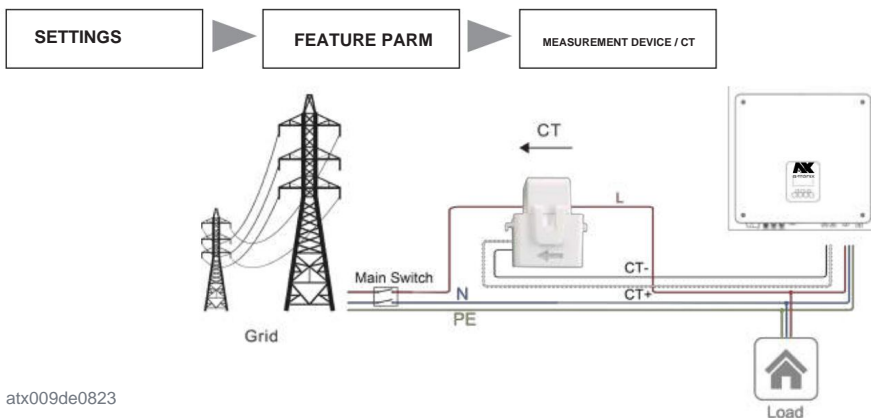

Operating instructions a-TroniX inverter AX series, 1ph



If there is another generator in the home, CT2 can be used to record the power produced by the generator and transmit the data to the website for monitoring.

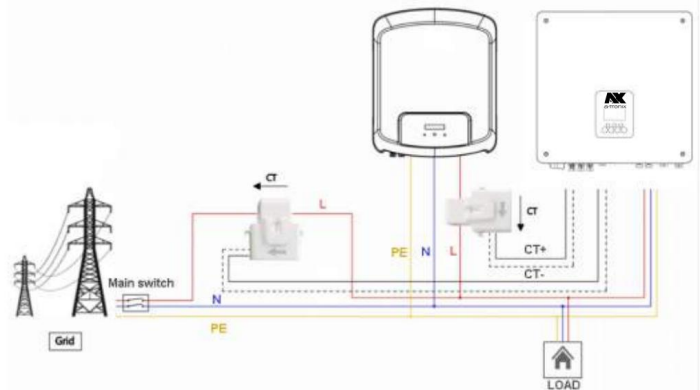

A NOTICE

For accurate reading and control of power, a meter can be used instead of a current transformer. If the current transformer is mounted in the wrong orientation, the backflow prevention function will fail

RS485:

RS485 is a standard communication interface that can transmit the real-time data from the inverter to PC or other monitoring devices.

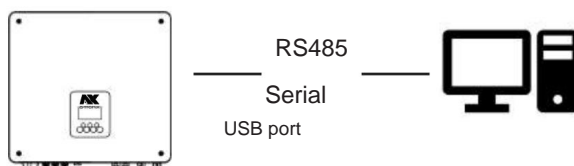

Measuring device (optional):

The inverter has an integrated export limitation function. To use this function, a power meter or current transformer must be installed. Please install the device on the network site.

Meter model	factory	Current	frequency	CT	model	Factory	ratio
SDM230-Modbus	EASTRON	0.5%		0.2%	CTSA016 YUANXING	100A/33.33mA	
DDSU666	CHINT	1%		1%	EICT-120K-T1000C	ELECMAT 120A/40mA	

Setting the export limit:



The ammeter is connected as follows:

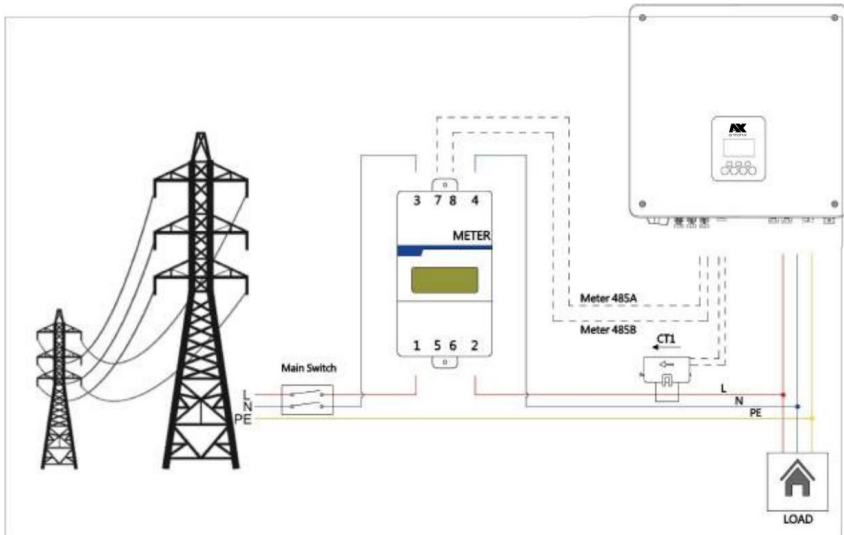

A NOTICE

Counter Type: DDSU666 (CHINT)

• BMS

The communication interface between inverter and battery is RS485 or CAN with an Rj45 connector.

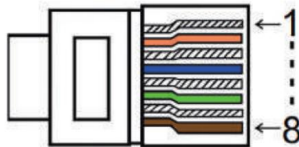

pin code	1	2	3	4	5	6	7	8th
definition	/ GND	BMS-485B	BMS-CANL	BMS-CANH	/		/	BMS-485A

Steps to connect:

Step 1:

Prepare a standard network cable and a
Insert the cable plug and then insert the power supply
factory cable through the cable connector.



Step 2:

Crimp the cable with an Rj45 connector located inside the cable connector.

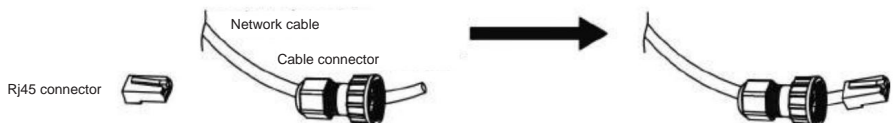

Step 3:

Insert the cable connector into the BMS port on the
bottom of the inverter and screw it tight.



• DRM

DRM0 setting:



The DRM supports multiple demand response modes by issuing control signals as described below.

Mode Conditions DRM0	
	Operate the disconnect device.
DRM1	Don't consume power.
DRM2	Consume no more than 50% of rated power.
DRM3	Do not use more than 75% of the rated power and use reactive power if possible.
DRM4	Increase power consumption (subject to limitations imposed by other active DRMs).
DRM5	Do not produce power.
DRM6	Generate no more than 50% of rated power.
DRM7	Do not generate more than 75% of the rated power and remove reactive power if possible.
DRM8	Increase power generation (subject to limitations imposed by other active DRMs).



A NOTICE

Currently only the DRM0 function is supported, other functions are under development.

DRM PIN definition:

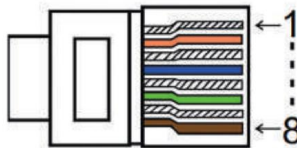

pin code	1	2	3	4	5	6	7	8
Definition	GND	GND	DRM0 +3.3V	DRM4/8	DRM3/7	DRM2/6	DRM1/5	

Model	Socket activated by shorting the pins		function
ESTOP	1	2	Emergency stop of the inverter.
DRM0	3	4	Operate the disconnect device.

Operating instructions

a-TroniX inverter AX series, 1ph



• COM

ESTOP: Close the inverter.

Generator: Connect the generator and put it into operation.

CAN: External debugging.

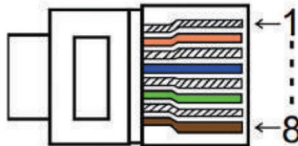

pin code	1	2	3	4	5	6	7	8th
Definition	+3.3V GND	GENERATOR	BMS-CANL	BMS-CANH	+3.3V GND	ESTOP		

Model	Socket activated by shorting the pins	function
ESTOP	7 8th	Emergency stop of the inverter.

Steps to connect:

Step 1:

Unscrew this plate from the inverter.

Step 2:

Prepare a standard network cable and cable connector and run the network cable.

cable through the cable connector.

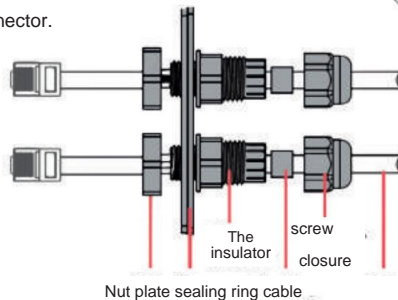

Step 3:

Insert the cable connector into the DRM/COM port on the bottom of the inverter and screw it tight. Then plug the other side of the network cable into the PC or other device.

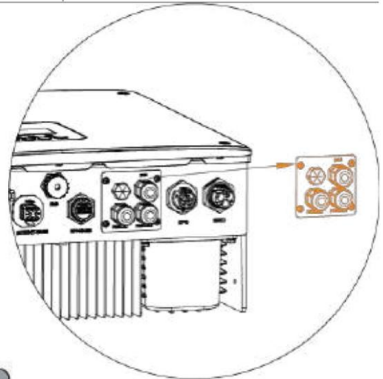

6.6 EPS connection

A. EPS wiring

EPS mode can be achieved by two different types of wiring. On the one hand, the internal bypass can be used to connect the home emergency call loads to the EPS connection of the inverter. Another is to use an external contactor to wire the EPS loads to the contactor itself (the external contactor must be purchased separately).



A NOTICE

The inverter is set to the EPS wiring mode “External” by default, it can be set to “Internal” via the display setting “Menu - Setting - Function - Bypass Relay”.

Using internal EPS wiring:

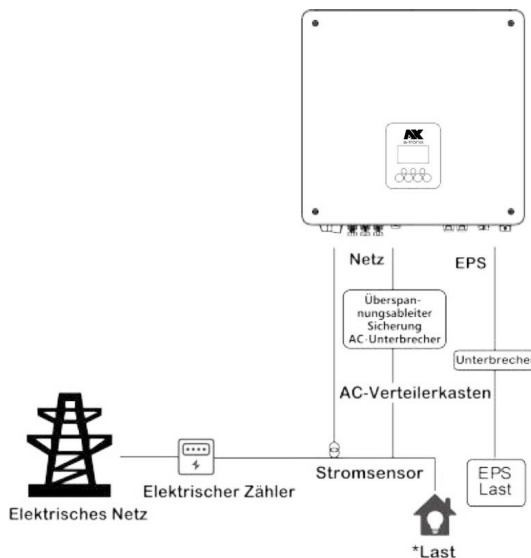

A NOTICE

1. During mains operation, ensure that the power of the EPS loads is lower is than the maximum bypass power of the inverter.
2. In off-grid operation, ensure the power of EPS loads is less than the maximum EPS power of the inverter.
3. We recommend not connecting inductive loads to the EPS port.

Using external EPS wiring:

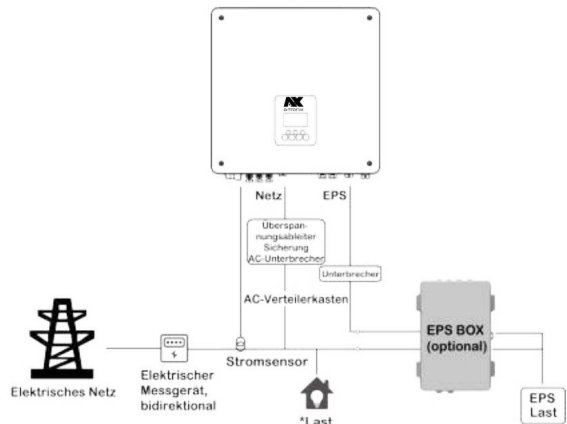

A NOTICE



1. EPS box (optional):

Used for on-grid and EPS switching of inverters, improves the maximum EPS load capacity, the max. bypass current is 60A.







2. When the grid is off, make sure the backup load power is lower than the inverter's maximum output power.

B. Description of shared burdens

When you connect an inductive load to the EPS port in EPS mode

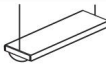
If you want to do this, please make sure that the instantaneous power of the load at startup is less than the maximum power of EPS mode. In the following table you will find some conventional and sensible loads for reference.

Please refer to your load manual for actual specifications.

Type	Performance		Common Device	Example		
	begin	Rated capacity		Device	begin	rated capacity
Resistive load	X1	X1	 light bulb  TV	 100W light bulb	100VA (W)	100VA (W)
Capacitive load	X2	X1.5	 fluorescent lamp	 40W luminous fabric lamp	80VA(W)	60VA(W)
Inductive load	X3~5X2		 fan Refrigerator	 150W Refrigerator	450~750 VA (W)	300VA (W)

6.7 System connection diagrams

The neutral conductor of the alternative power supply must be isolated or switched. For countries such as **Australia, New Zealand, South Africa, etc.**, please follow local wiring regulations.

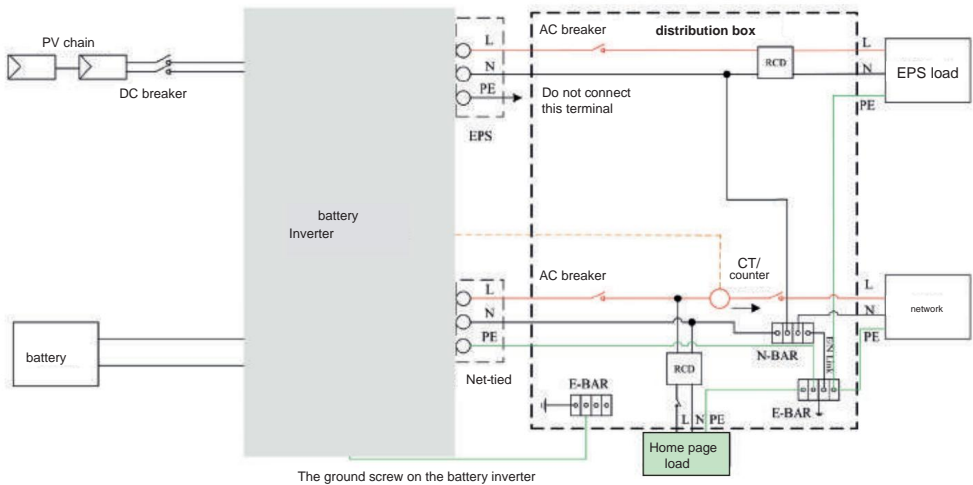

The neutral line of the alternative power supply must be disconnected after the mains is switched off. For countries such as **China, Germany, Czech Republic, Italy, etc.**, please follow **local wiring regulations**.

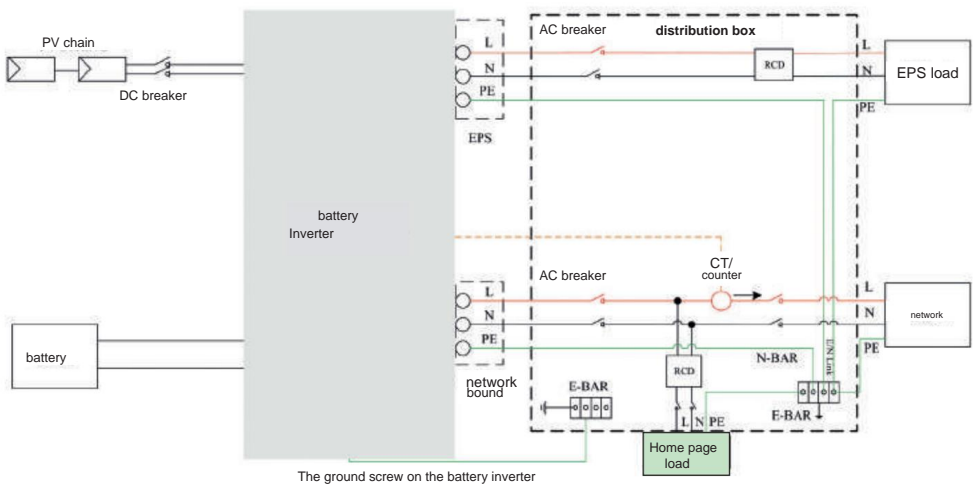

6.8 Put the inverter into operation

Please note the following steps for commissioning the inverter.

1. Make sure the inverter is well secured.
2. Make sure all DC and AC wiring is completed.
3. Make sure the current transformer/meter is connected correctly.
4. Make sure the battery is well connected.
5. Make sure the external EPS contactor is well connected (if it is conducive).
6. Turn on the PV/DC switch (Only for Hybrid), the AC breaker, the EPS breaker and the battery breaker.
8. Enter the settings page, the default password is '0000', select Press START/STOP and set it to Start.



A NOTICE

- When you start the inverter for the first time, the country code defaults to the local settings. Please check
Check whether the country code is correct.
- Set the time on the inverter using the or button
the APP.
- The internal bypass relay is closed by default. If you want it to open, go to the settings page and select
"Internal".
- The EPS function is turned off by default when opened
go to the settings page and select EPS "ON/
OFF", the default EPS voltage/frequency is 230V and 50Hz.

6.9 Switch off the inverter

Please refer to the following steps to turn off the inverter.

1. Enter the setting page, select and set START/STOP
to stop.
2. Turn on the PV/DC switch (Only for 3ph), AC breaker, EPS
circuit breaker and the battery circuit breaker.
3. Wait 5 minutes before opening the top lid (if in need of repair).

7. Surgery

7.1 Control panel

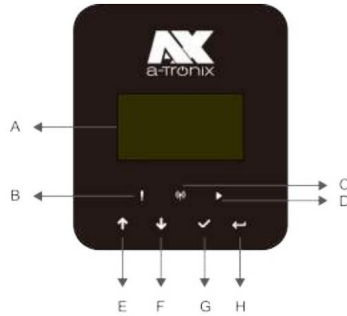

object	Surname	function
A	LCD screen displaying the inverter information.	
b	Indicator LED	Red: The inverter is in fault mode.
C		Blue: The inverter is normally connected to the battery.
D		Green: The inverter is in normal condition.
E	Function key	upward Button: Move cursor up or increase value.
F		Down button: Move cursor down or decrease value.
G		OK button: Confirm the selection.
H		Return-Button: Return to the previous process.

7.2 Function tree

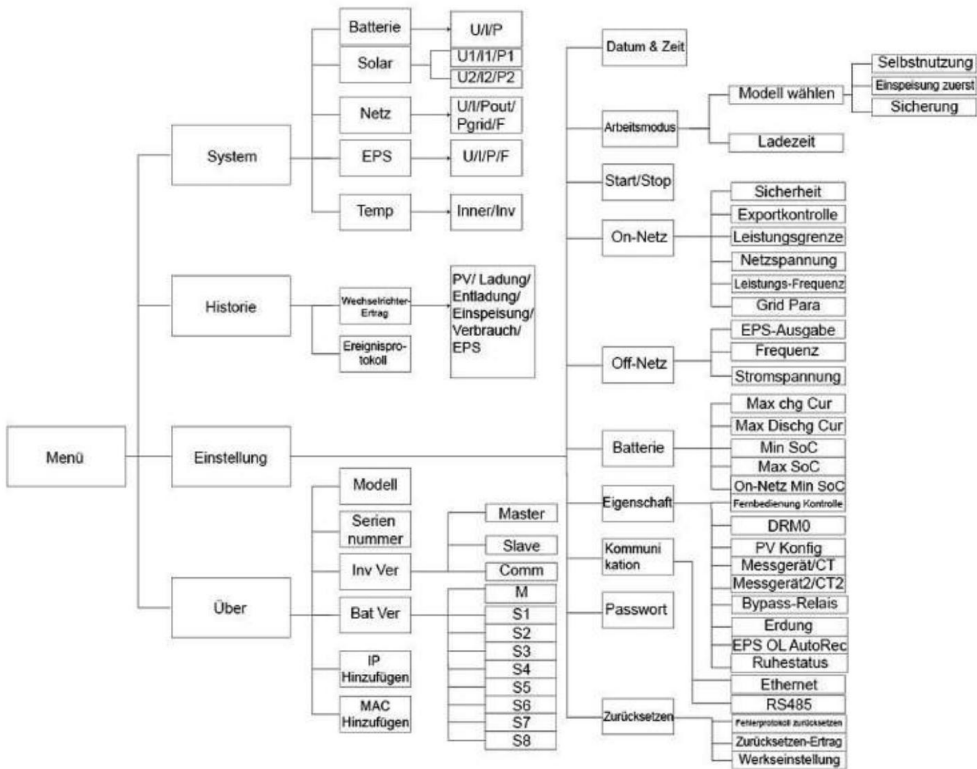

8. Maintenance

This section provides information and procedures for troubleshooting possible problems with the a-TroniX inverters and gives you troubleshooting tips to identify and solve most problems that may arise.

8.1 Alarm list

Error code	Solution
Grid loss error	<p>The power grid is interrupted.</p> <ul style="list-style-type: none"> • The system will turn back on when the power returns to normal. • Or seek help from us if you cannot return to normal.
Mains voltage error	<p>Mains voltage out of range.</p> <ul style="list-style-type: none"> • The system will turn back on when the power returns to normal. • Or seek help from us if you cannot return to normal.
Mains frequency error	<p>Mains frequency out of range.</p> <ul style="list-style-type: none"> • The system will turn back on when the power returns to normal. • Or seek help from us if you cannot return to normal.
10 mins Tension Mistake	<p>The mains voltage has been out of range for the last 10 minutes.</p> <ul style="list-style-type: none"> • The system will turn back on when the power returns to normal. • Or seek help from us if you cannot return to normal.
SW Inv Cur Mistake	<p>High output current detected by software.</p> <ul style="list-style-type: none"> • Disconnect the PV, grid and battery and then reconnect them. • Or seek help from us if you cannot return to normal.
DCI Mistake	<p>DC component in the output current is outside the limit.</p> <ul style="list-style-type: none"> • Disconnect the PV, grid and battery and then reconnect them. • Or seek help from us if you cannot return to normal.
HW Inv Cur Mistake	<p>Output current high detected by hardware.</p> <ul style="list-style-type: none"> • Disconnect the PV, grid and battery and then reconnect them. • Or seek help from us if you cannot return to normal.
SW Bus Vol Mistake	<p>Bus voltage out of range detected by software.</p> <ul style="list-style-type: none"> • Disconnect the PV, grid and battery and then reconnect them. • Or seek help from us if you cannot return to normal.
Bat tension Mistake	<p>Battery voltage error.</p> <ul style="list-style-type: none"> • Check whether the battery input voltage is within the normal range. • Or seek help from us.
SW Bat Cur Mistake	<p>High battery current detected by software.</p> <ul style="list-style-type: none"> • Disconnect the PV, grid and battery and then reconnect them. • Or seek help from us if you cannot return to normal.
Iso Mistake	<p>The insulation has failed.</p> <ul style="list-style-type: none"> • Check whether the insulation of the electrical wires is damaged. • Wait a while to check if the insulation returns to normal. • Or seek help from us.

Operating instructions a-TroniX inverter AX series, 1ph



Error code	Solution
Res Cur Mistake	The differential current is high. • Check whether the insulation of the electrical wires is damaged. • Wait a while to check if the insulation returns to normal. • Or seek help from us.
PV voltage Mistake	PV voltage out of range. • Please check the output voltage of the PV panels. • Or seek help from us.
SW PV Cur Mistake	PV input current high detected by software. • Disconnect the PV, grid and battery and then reconnect them. • Or seek help from us if you cannot return to normal.
Temp Mistake	The inverter temperature is high. • Please check whether the ambient temperature is correct. • Wait a while to check if the insulation returns to normal. • Or seek help from us.
Ground defects	The connection has failed. • Check the voltage of the neutral conductor and PE. • Check AC wiring. • Disconnect the PV, grid and battery and then reconnect them. • Or seek help from us if you cannot return to normal.
Overload Mistake	Overload in network operation. • Please check whether the load power exceeds the limit. • Or seek help from us.
EPS overload	Overload in off-grid mode. • Please check whether the EPS load power exceeds the limit. • Or seek help from us.
Low Battery power	Battery power is low. • Wait until the battery is recharged. • Or seek help from us.
HW bus Tension Mistake	Bus voltage out of range detected by hardware. • Disconnect the PV, grid and battery and then reconnect them. • Or seek help from us if you cannot return to normal.
HW PV Cur Mistake	PV input current high detected by hardware. • Disconnect the PV, grid and battery and then reconnect them. • Or seek help from us if you cannot return to normal.
HW Bat Cur Mistake	High battery current detected by hardware. • Disconnect the PV, grid and battery and then reconnect them. • Or seek help from us if you cannot return to normal.
SCI Mistake	Communication between master and manager has failed. • Disconnect the PV, grid and battery and then reconnect them. • Or seek help from us if you cannot return to normal.

Operating instructions

a-TroniX inverter AX series, 1ph



Error code	Solution
MDSP SPI Mistake	Communication between master and slave has failed. <ul style="list-style-type: none"> • Disconnect the PV, grid and battery and then reconnect them. • Or seek help from us if you cannot return to normal.
MDSP SmpI Mistake	The master sample detection circuit has failed. <ul style="list-style-type: none"> • Disconnect the PV, grid and battery and then reconnect them. • Or seek help from us if you cannot return to normal.
Res Cur HW Mistake	Residual current detection device has failed. <ul style="list-style-type: none"> • Disconnect the PV, grid and battery and then reconnect them. • Or seek help from us if you cannot return to normal.
Inv EEPROM Mistake	The inverter's Eeprom is faulty. <ul style="list-style-type: none"> • Disconnect the PV, grid and battery and then reconnect them. • Or seek help from us if you cannot return to normal.
PvCon Dir Mistake	The PV connection is swapped. <ul style="list-style-type: none"> • Check whether the positive and negative poles of the PV are connected correctly. • Or seek help from us.
Bat relay open	The battery relay remains open. <ul style="list-style-type: none"> • Disconnect the PV, grid and battery and then reconnect them. • Or seek help from us if you cannot return to normal.
Bat Relay Short circuit	The battery relay remains closed. <ul style="list-style-type: none"> • Disconnect the PV, grid and battery and then reconnect them. • Or seek help from us if you cannot return to normal.
Bat Buck Mistake	The battery step down mosfet has failed. <ul style="list-style-type: none"> • Disconnect the PV, grid and battery and then reconnect them. • Or seek help from us if you cannot return to normal.
Bat Boost Mistake	The battery boost circuit mosfet has failed <ul style="list-style-type: none"> • Disconnect the PV, grid and battery and then reconnect them. • Or seek help from us if you cannot return to normal.
EPS relay Mistake	The EPS relay has failed. <ul style="list-style-type: none"> • Disconnect the PV, grid and battery and then reconnect them. • Or seek help from us if you cannot return to normal.
BatCon Dir Mistake	The battery connection is reversed. <ul style="list-style-type: none"> • Check whether the positive and negative poles of the battery are connected correctly. • Or seek help from us.
Main relay open	The mains relay remains open. <ul style="list-style-type: none"> • Disconnect the PV, grid and battery and then reconnect them. • Or seek help from us if you cannot return to normal.
S1 close error	S1 Error closing <ul style="list-style-type: none"> • Disconnect the PV, grid and battery and then reconnect them. • Or seek help from us if you cannot return to normal.
S2 close error	S2 Error closing <ul style="list-style-type: none"> • Disconnect the PV, grid and battery and then reconnect them. • Or seek help from us if you cannot return to normal.

Operating instructions

a-TroniX inverter AX series, 1ph



Error code	Solution
M1 error close	<p>M1 Error closing</p> <ul style="list-style-type: none"> • Disconnect the PV, grid and battery and then reconnect them. • Or seek help from us if you cannot return to normal.
M2 error close	<p>M2 Error closing</p> <ul style="list-style-type: none"> • Disconnect the PV, grid and battery and then reconnect them. • Or seek help from us if you cannot return to normal.
GridV Cons Mistake	<p>The sample value of the mains voltage between master and slave is not consistent.</p> <ul style="list-style-type: none"> • Disconnect the PV, grid and battery and then reconnect them. • Or seek help from us if you cannot return to normal.
GridF Cons Mistake	<p>The sample value of the network frequency between master and slave is not consistent.</p> <ul style="list-style-type: none"> • Disconnect the PV, grid and battery and then reconnect them. • Or seek help from us if you cannot return to normal.
Dci Cons Mistake	<p>The dci sample value between master and slave is not consistent.</p> <ul style="list-style-type: none"> • Disconnect the PV, grid and battery and then reconnect them. • Or seek help from us if you cannot return to normal.
RC Cons Mistake	<p>The differential current sample between master and slave is not consistent.</p> <ul style="list-style-type: none"> • Disconnect the PV, grid and battery and then reconnect them. • Or seek help from us if you cannot return to normal.
RDSP SPI Mistake	<p>Communication between master and slave has failed.</p> <ul style="list-style-type: none"> • Disconnect the PV, grid and battery and then reconnect them. • Or seek help from us if you cannot return to normal.
RDSP Smpl Mistake	<p>The slave sample detection circuit has failed.</p> <ul style="list-style-type: none"> • Disconnect the PV, grid and battery and then reconnect them. • Or seek help from us if you cannot return to normal.
ARM EEPROM Mistake	<p>The eeprom manager is faulty.</p> <ul style="list-style-type: none"> • Disconnect the PV, grid and battery and then reconnect them. • Or seek help from us if you cannot return to normal.
Gauge loss error	<p>The communication between the measuring device and the inverter is interrupted.</p> <ul style="list-style-type: none"> • Check whether the communication cable between the meter and the inverter is correctly and well connected.
BMS Loss	<p>Communication between BMS and inverter is interrupted.</p> <ul style="list-style-type: none"> • Check whether the communication cable between the meter and the inverter is correctly and well connected.
BMS Ext Mistake	<p>Communication between BMS and inverter is interrupted.</p> <ul style="list-style-type: none"> • Check whether the communication cable between the meter and the inverter is correctly and well connected.

Operating instructions

a-TroniX inverter AX series, 1ph



Error code	Solution
BMS Int Mistake	DIP switch in wrong position; Communication between the battery packs is interrupted. <ul style="list-style-type: none"> Put the DIP switch in the correct position; Check whether the communication cable between the battery packs is connected correctly and well.
BMS voltage high	Battery overvoltage. Please contact battery suppliers.
BMS voltage low Battery undervoltage	Battery undervoltage. Please contact battery suppliers.
BMS ChgCur high	Battery charging via electricity. Please contact battery suppliers.
BMS DchgCur high	Battery discharge via electricity. Please contact battery suppliers.
BMS temp high	Battery over temperature. Please contact battery suppliers.
BMS temp low	Battery under temperature. Please contact battery suppliers.
BMS Cellimbalance	The capacities of the cells are different. <ul style="list-style-type: none"> Please contact battery suppliers.
BMS HW protection	Battery hardware under protection. Please contact battery suppliers
BMS circuit error	BMS hardware circuit error. Please contact battery suppliers.
BMS island error	Battery insulation fault. Please contact battery suppliers.
BMS VoltsSen error	Battery voltage sensor error. <ul style="list-style-type: none"> Please contact battery suppliers.
BMS TempSen error	Battery temperature sensor error. Please contact battery suppliers.
BMS CurSen error	Battery current sensor error. <ul style="list-style-type: none"> Please contact battery suppliers.
BMS relay error	Battery relay error. Please contact battery suppliers.
BMS type not to match	The capacity of the battery packs varies. <ul style="list-style-type: none"> Please contact battery suppliers.
BMS ver not to match	The software between the slaves is different. <ul style="list-style-type: none"> Please contact battery suppliers.
BMS Mfg not to match	Cell manufacturing varies. <ul style="list-style-type: none"> Please contact battery suppliers.
BMS SwHw not to match	The slave software and hardware do not match. <ul style="list-style-type: none"> Please contact battery suppliers.
BMS M&S does not to match	The software between master and slave does not match. <ul style="list-style-type: none"> Please contact battery suppliers.
BMS ChgReq NoAck	No action for load request. <ul style="list-style-type: none"> Please contact battery suppliers.

8.2 Troubleshooting and routine maintenance

• Troubleshooting

- a. Please check the error message on the system control panel or the error code on the inverter information panel. If a message appears, write it down before taking any further action.
- b. Try the solution given in the table above.
- c. If the inverter information panel does not display an error message, check the following to ensure that the current state of the installation allows the device to operate properly:
 - (1) Is the inverter in a clean, dry and sufficiently ventilated place?
 - (2) Are the DC input circuit breakers open?
 - (3) Are the cables sufficiently dimensioned?
 - (4) Are the input and output connections and wiring in good condition
Condition?
 - (5) Are the configuration settings correct for your particular installation?
 - (6) Are the display panel and communication cable connected correctly and undamaged?

Contact a-TronIX customer service for further assistance. Please be prepared to describe details of your system installation and provide the device model and serial number.

• Safety test

A safety check should be carried out at least every 12 months by a qualified technician who has appropriate training, knowledge and practical experience to carry out these checks.

The data should be recorded in a device log.

If the device does not function properly or fails one of the tests, the device must be repaired. For details on safety checks, see Section 2 of this manual.

• Maintenance checklist

While using the inverter, the responsible person must regularly check and maintain the device. The required actions are as follows.

- Check for dust/dirt accumulation on the cooling fins on the back of the inverter and clean the machine if necessary. This work should be carried out at regular intervals.

- Check whether the inverter displays are in normal state, check whether the inverter display is normal. These checks should be carried out at least every 6 months.
- Check whether the input and output cables are damaged or aged. This check should be carried out at least every 6 months.
- Have the inverter panels cleaned and checked for safety at least every 6 months.



A NOTICE

Only qualified persons may carry out the following work.

9. Decommissioning

9.1 Dismantling the inverter

- Disconnect the inverter from the DC (only for hybrid) input and AC output. Wait 5 minutes until the inverter is completely de-energized.
- Disconnect the communication and optional connection cables. Remove the inverter from the holder.
- Remove the bracket if necessary.

9.2 Packaging

Please pack the inverters in the original packaging if possible. If this is no longer available, you can also use equivalent packaging that meets the following requirements.

- Suitable for loads of more than 30 kg.
- Includes a carrying handle.
- Can be completely closed.

9.3 Storage and transport

Store the inverters in a dry place where the ambient temperature is always between -40°C and $+70^{\circ}\text{C}$. Please ensure that the inverters are kept no more than 4 boxes in a stack during storage and transportation. If the inverter or other associated components need to be disposed of, please ensure that this is done in accordance with local waste disposal regulations. Make sure that the inverter that needs to be disposed of is delivered to locations that are suitable for disposal in accordance with local regulations.



www.a-tronix.de



AKKU SYS Accumulator and Battery Technology Nord GmbH

Connection path 23 · 25469 Halstenbek · GERMANY Phone +49
4101 37676-0 · info@akkusys.de www.akkusys.de ·
akkusys.shop · www.a-tronix.de



INVERTERS

User Manual

AX series, 1ph



INTRODUCTION

The publication and copyright of this documentation remain with the company:

AKKU SYS Accumulator and Battery Technology Nord GmbH

Connection path 23 D-25469 Halstenbek · GERMANY

Phone +49 4101 37676-0 · Fax +49 4101 85475-66

info@akkusys.de · www.akkusys.de · akkusys.shop

Read carefully before use!

Read this manual carefully before installation.

It contains important regulations and instructions for the use of this product and provides technical support for the operator of the unit.

All rights reserved.

AKKU SYS Akkumulator- und Batterietechnik Nord GmbH cannot be held responsible for any inaccuracies or inappropriate information in this instruction manual.

The information in this document is subject to change without notice, but there is no obligation to update it on an ongoing basis.

We reserve the right to make design and equipment changes to improve the production process or the product. AKKU SYS GmbH accepts no liability for errors in this operating manual and any consequences resulting therefrom.

Our EU declaration of conformity and warranty conditions can be found on:

www.a-tronix.de

Table of Contents

	page
1. Notes on This Manual	50
1.1 Scope of Validity	50
1.2 Target Group	50
1.3 Symbols Used	50
2. Safety	50
2.1	51
2.2 Appropriate Usage	51
2.3 PE Connection and Leakage Current	52
2.3 Surge Protection Devices (SPDs) for PV Installation	54
3. Introduction	55
3.1 Basic Features	55
3.2 Dimensions	56
3.3 Terminals of inverters	57

4. Technical data	58
4.1 PV Input (For 3ph Only)	58
4.2 Battery 4.3	58
AC Output/Input 4.4 EPS	59
Output 4.5 Efficiency	60
and Protection 4.6 General Data	60
	61
5. Installation	62
5.1 Check for Physical Damage 5.2	62
Packing List 5.3	62
Mounting 6.	63
Electrical Connection	66
6.1 PV Connection (For 3ph Only)	66
6.2 Battery Connection 6.3	68
Grid Connection	69
6.4 Earth Connection	72
6.5 Electrical Connection	72
6.6 EPS Connection (Non-parallel State)	79
6.7 System Connection Diagrams 6.8	81
Inverter Start-Up 6.9	82
Inverter Switch Off	82
7. Surgery	83
7.1 Control Panel	83
7.2 Function Tree	84
8.Maintenance	85
8.1 Alarm List	85
8.2 Troubleshooting and Routine Maintenance 9.	90
Decommissioning 9.1	91
Dismantling the Inverter 9.2	91
Packaging 9.3	91
Storage and Transportation	91

1. Notes on This Manual

1.1 Scope of Validity

This manual describes the assembly, installation, commissioning, maintenance and troubleshooting of the following model(s) of products:

AX3.0kW-1ph, AX3.7kW-1ph, AX4.6kW-1ph, AX5.0kW-1ph, AX6.0kW-1ph



GRADE

Please keep this manual where it will be accessible at all times.

1.2 Target Group

This manual is for qualified electricians. The tasks described in this manual only can be performed by qualified electricians.

1.3 Symbols Used

The following types of safety instructions and general information appear in this document as described below:



DANGER!

WARNING!

CAUTION!

The Symbol indicates a hazardous situation which, if not avoided, will result in death or serious injury.



GRADE

“Note” provides important tips and guidance.

This section explains the symbols shown on the inverter and on the type label:



Symbol Explanation CE mark. The inverter complies with the requirements of the applicable CE guidelines.



This mark indicates compound UK product safety certification requirements.



Beware of hot surfaces. The inverter can become hot during operation. Avoid contact during operation.



Danger of high voltages.
Danger to life due to high voltages in the inverter!



Danger.
Risk of electric shock!



Danger to life due to high voltage.

There is residual voltage in the inverter which needs 5 minutes to discharge. Wait 5 minutes before you open the upper lid or the DC lid.



Read the manual.



Product should not be disposed of as household waste.



PE conductor terminal

2. Safety

2.1 Appropriate Usage

a-TroniX AX series inverters are designed and tested in accordance with international safety requirements. However, certain safety precautions must be taken when installing and operating this inverter. The installer must read and follow all instructions, cautions and warnings in this installation manual. • All operations including transport, installation, start-up and maintenance, must be carried out by qualified, trained personnel.

- The electrical installation & maintenance of the inverter shall be conducted by a licensed electrician and shall comply with local wiring rules and regulations. •

Before installation, check the unit to ensure it is free of any transport or handling damage, which could affect insulation integrity or safety clearances.

Choose the installation location carefully and adhere to specified cooling requirements. Unauthorized removal of necessary protections, improper use, incorrect installation and operation may lead to serious safety and shock hazards or equipment damage.

- Before connecting the inverter to the power distribution grid, contact the local power distribution grid company to get appropriate approvals. This connection must be made only by qualified technical personnel. • Do not install the

equipment in adverse environmental conditions such as in close proximity to flammable or explosive substances; in a corrosive or desert environment; where there is exposure to extreme high or low temperatures; or where humidity is high.

- Do not use the equipment when the safety devices do not work or are disabled. •

Use personal protective equipment, including gloves and eye protection during the installation.

- Inform the manufacturer about non-standard installation conditions.
- Do not use the equipment if any operating anomalies are found.
Avoid temporary repairs.
- All repairs should be carried out using only approved spare parts, which must be installed in accordance with their intended use and by a licensed contractor or authorized service representative. •

Liabilities arising from commercial components are delegated to their respective manufacturers. •

Any time the inverter has been disconnected from the public network, please be extremely cautious as some components can retain charge sufficient to create a shock hazard. Prior to touching any part of the inverter please ensure surfaces and equipment are under touch safe temperatures and voltage potentials before proceeding.

2.2 PE Connection and Leakage Current

PV System Residual Current Factors • In

every PV installation, several elements contribute to the current leakage to protective earth (PE). these elements can be divided into two main types. • Capacitive

discharge current - Discharge current is generated mainly by the parasitic capacitance of the PV modules to PE. The module type, the environmental conditions (rain, humidity) and even the distance of the modules from the roof can effect the discharge current. Other factors that may contribute to the parasitic capacitance are the inverter's internal capacitance to PE and external protection elements such as lighting protection. • During operation, the DC bus is

connected to the alternating current grid via the inverter. Thus, a portion of the alternating voltage amplitude arrives at the DC bus. The fluctuating voltage constantly changes the charge state of the parasitic PV capacitor (ie capacitance to PE). This is associated with a displacement current, which is proportional to the capacitance and the applied voltage amplitude.

- Residual current - if there is a fault, such as defective insulation, where an energized cable comes into contact with a grounded person, an additional current flows, known as a residual current.

Residual Current Device (RCD) • All

inverters incorporate a certified internal RCD (Residual Current Device) to protect against possible electrocution in case of a malfunction of the PV array, cables or inverter (DC). The RCD in the inverter can detect leakage on the DC side. There are 2 trip thresholds for the RCD as required by the DIN VDE 0126-1-1 standard. A low threshold is used to protect against rapid changes in leakage typical of direct contact by people. A higher threshold is used for slowly rising leakage currents, to limit the current in grounding conductors for the safety. The default value for higher speed personal protection is 30mA, and 300mA per unit for lower speed fire safety.

Installation and Selection of an External RCD device

- An external RCD is required in some countries. The installer must check which type of RCD is required by the specific local electrical codes. Installation of an RCD must always be conducted in accordance with local codes and standards. Recommends the use of a type-A RCD. Unless a lower value is required by the specific local electrical codes, Suggests an RCD value between 100mA and 300mA.
- In installations where the local electrical code requires an RCD with a lower leakage setting, the discharge current might result in nuisance tripping of the external RCD. The following steps are recommended to avoid nuisance tripping of the external RCD:
 1. Selecting the appropriate RCD is important for correct operation of the installation. An RCD with a rating of 30mA may actually trip at a leakage as 15mA (according to IEC 61008). High quality RCDs will typically trip at a value closer to their rating.
 2. Configure the trip current of the inverter' internal RCD to a lower value than the trip current of the external RCD. The internal RCD will trip if the current is higher than the allowed current, but because the internal inverter RCD automatically resets when the residual currents are low it saves the manual reset.

2.3 Surge Protection Devices (SPDs) for PV installation



WARNING

Over-voltage protection with surge arresters should be provided when the PV power system is installed. The grid connected inverter is not fitted with SPDs in both PV input side and mains side.

Lightning will cause damage either from a direct strike or from surges due to a nearby strike.

Induced surges are the most likely cause of lightning damage in majority of installations, especially in rural areas where electricity is usually provided by long overhead lines. Surges may affect both the PV array conduction and the AC cables leading to the building. Specialists in lightning protection should be consulted during the end use application. Using appropriate external lightning protection, the effect of a direct lightning strike into a building can be mitigated in a controlled way, and the lightning current can be discharged into the ground.

Installation of SPDs to protect the inverter against mechanical damage and excessive stress include a surge arrester in case of a building with external lightning protection system (LPS) when separation distance is kept. To protect the DC system, surge suppression device (SPD type2) should be fitted at the inverter end of the DC cabling and at the array located between the inverter and the PV generator, if the voltage protection level (VP) of the surge arresters is greater than 1100V, an additional SPD type 3 is required for surge protection for electrical devices.

To protect the AC system, surge suppression devices (SPD type2) should be fitted at the main incoming point of AC supply (at the consumer's cutout), located between the inverter and the meter/distribution system; SPD (test impulse D1) for signal line according to EN 61632-1. All DC cables should be installed to provide as short a run as possible, and positive and negative cables of the string or main DC supply should be bundled together.

Avoiding the creation of loops in the system. This requirement for short runs and bundling includes any associated earth bundling conductors. Spark gap devices are not suitable to be used in DC circuits once conducting; they won't stop conducting until the voltage across their terminals is typically below 30 volts.

3.Introduction

3.1 Basic Features

AX series are high-quality inverters which can convert solar energy to AC energy and store energy into battery. The inverter can be used to optimize self-consumption, store in the battery for future use or feed-in to public grid.

Work mode depends on PV energy and user's preference.

System advantages:

- Advanced DSP control technology.
- Utilizes the latest high-efficiency power component.
- Advanced anti-islanding solutions.
- IP65 protection level.
- Max. Efficiency up to 97.8%. EU efficiency up to 97.0%. THD<3%.
- Safety & Reliability: Transformerless design with software and hardware protection.
- Export limitation (CT/Meter/DRM0/ESTOP).
- Power factor regulation. Friendly HMI.
- LED status indications.
- LCD display technical data, human-machine interaction through four touch keys.
- PC remote control.

Work modes

Work modes	Description
Self-use (with PV power)	Priority: load>battery>grid The energy produced by the PV system is used to optimize self-consumption. The excess energy is used to charge the batteries, then exported to grid.
Self-use (without PV Power)	When no PV supplied, battery will discharge for local loads firstly, and grid will supply power when the battery capacity is not enough.
Feed in priority	Priority: load>grid>battery In the case of the external generator, the power generated will be used to supply the local loads firstly, then export to the public grid. The redundant power will charge the battery.
Force time use	Priority: battery>load>grid (when charging) Priority: load>battery>grid (when discharging) This mode applies the area that has electricity price between peak and valley. User can use off-peak electricity to charge the battery. The charging and discharging time can be set flexibly, and it also allows to choose whether charge from the grid or not.
Back up mode	When the grid is off, system will supply emergency power from PV or battery to supply the home loads (Battery is necessary in EPS mode).

3.2 Dimensions

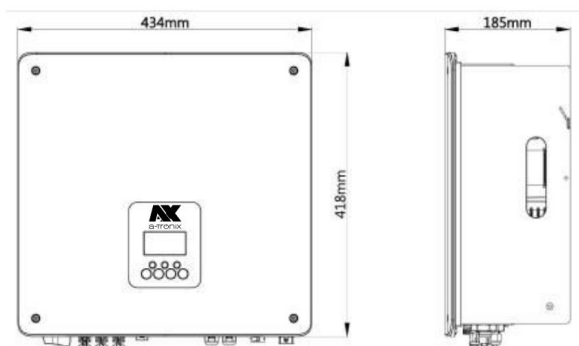

3.3 Terminals of Inverters

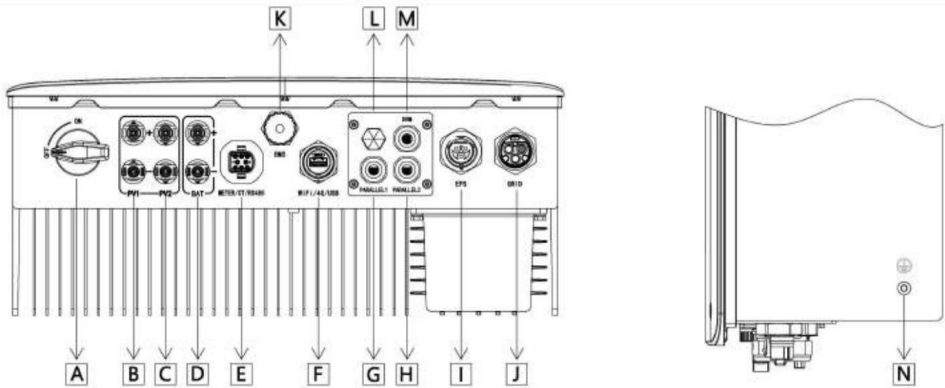

item	Description
A	DC Switch (For Hybrid Only)
b	PV1 (For Hybrid Only)
C	PV2 (For Hybrid Only)
D	Battery connector
E	Meter/CT/RS485
F	WiFi/4G/USB
G	PARALLEL 1
H	PARALLEL 2
I	EPS
J	GRID
K	BMS
L	Waterproof lock valve
M	DRM
N	Grounding screw



GRADE

Only authorized personnel are permitted to set the connection.

4. Technical data

4.1 PV Input (For Hybrid Only)

Model AX, 1ph	3kW	3.7kW	4.6kW	5kW	6kW
PV					
Max. recommended DC power [W]	4500 A:2250 B:2250	5500 A:2750 B:2750	6900 A:3450 B:3450	7500 A:3750 B:3750	9000 A:4500 B:4500
Max. DC voltage [V]	600				
Nominal DC operating voltage [V]	360				
Max. input current (input A / input B) [A]	16/16				
Max. short circuit current (input A / input B) [A]	20/20				
Max. inverter backfeed current to the array [mA]	0				
MPPT voltage range [V]	80-550				
Start-up voltage [V]	100				
No. of MPP trackers	2				
Strings via MPP tracker	1				
DC switch	Optional				

4.2 Battery

Model AX, 1ph	3kW	3.7kW	4.6kW	5kW	6kW
Battery					
Battery type	LFP				
Battery voltage range [V]	80-480				
Recommended battery voltage [V]	300Vdc				
Max. charge / discharge current [A]	40/40				
Communication interface	CAN/RS485				
Reverse connection protection	Yes				
Operating temperature [°C]	-10 ~ +50				
Storage temperature [°C]	-20 ~ +50				

4.3 AC Output/Input

Model AX, 1ph	3kW	3.7kW	4.6kW	5kW	6kW
AC OUTPUT					
Nominal AC power [VA]	3000	3680	4600	5000	6000
Max. apparent AC power [VA]	3300	4048	4600	5500	6600
Rated grid voltage (AC voltage range) [V]	220 / 230 / 240 (180 to 270)				
Rated grid frequency [Hz]	50 / 60, ±5				
Nominal AC current [A]	13.6	16.7	20.9	22.7	27.3
Max. AC current [A]	15.0	18.4	23.0	25.0	30
Inrush current [A]	9.6A@50us				
Max. output fault current [A]	130A@ 10us				
Max. output overcurrent protection [A]	35	36.7	45.8	47.7	57.4
Displacement power factor	0.8 leading to 0.8 lagging				
Total harmonic distortion (THDi, rated power)	<3%@ rated power				
AC INPUT					
Max. AC power [VA]	6000	7680	9200	10000	12000
Max. AC current [A]	27.3	34.9	41.8	45.5	54.5

4.4 EPS output

Model AX, 1ph	3kW	3.7kW	4.6kW	5kW	6kW
EPS Output (WITH BATTERY)					
Max. EPS power [VA]	3000	3680	4600	5000	6000
EPS rated voltage[V], Frequency [Hz]	220/230/240VAC, 50/60				
EPS peak power (60s) [W]	3600	4400	5500	6000	7200
Max. EPS current [A]	13.6	16.7	20.9	22.7	27.3
Switch time [s]	<20ms				
Total harmonic distortion (THDv, linear load)	<2%@ rated power				

4.5 Efficiency, Safety and Protection

Model AX, 1ph	3kW	3.7kW	4.6kW	5kW	6kW
EFFICIENCY					
MPPT efficiency	99.90%				
Euro efficiency	95.26%	95.70%	96.23%	96.30%	96.33%
MPPT efficiency	97.01%	97.08%	97.04%	97.08%	97.08%
Max. battery charge efficiency (PV to BAT) (@full load)	98.50%				
Max. battery discharge efficiency (BAT to AC) (@full load)	97.00%				
Standby consumption [W]	<10				
DEFAULT					
Safety	EN 62109-1/ EN 62109-2				
EMC	IEC EN 61000-6-1/ IEC EN 61000-6-2/ IEC EN 61000-6-3/IEC EN 61000-6-4				
Certification	G99 / EN50549-1 / CEI 0-21 / VDE-AR-N 4105 and so on				

4.6 General Data

Model AX, 1ph	3kW	3,7kW	4.6kW	5kW	6kW
DIMENSION AND WEIGHT					
Dimension (W*H*D) [mm]	434*418*185				
Weight [kg]	22				
Cooling concept	Natural				
Inverter topology	Non-Isolated				
Communication	WiFi / LAN / 4G /GPRS (optional), DRM, USB, CT				
LCD display	LCD, app, website				
ENVIRONMENT LIMIT					
Ingress protection	IP65				
Protective Class	Class I				
Operating temperature range [°C]	-25 ~ +60 (derating at +45°C)				
Humidity [%]	0% ~ 100 (non-condensing)				
altitude [m]	<2000				
Storage temperature [°C]	-40 ~ +70				
Noise emission (typical) [dB]	<35				
Over voltage category	III (AC), II (DC)				

5. Installation

5.1 Check for Physical Damage

Make sure the inverter is intact during transportation. If there is any visible damage, such as cracks, please contact your dealer immediately.

5.2 Packing List

Open the package and take out the product, please check the accessories first.

The packing list shown below.

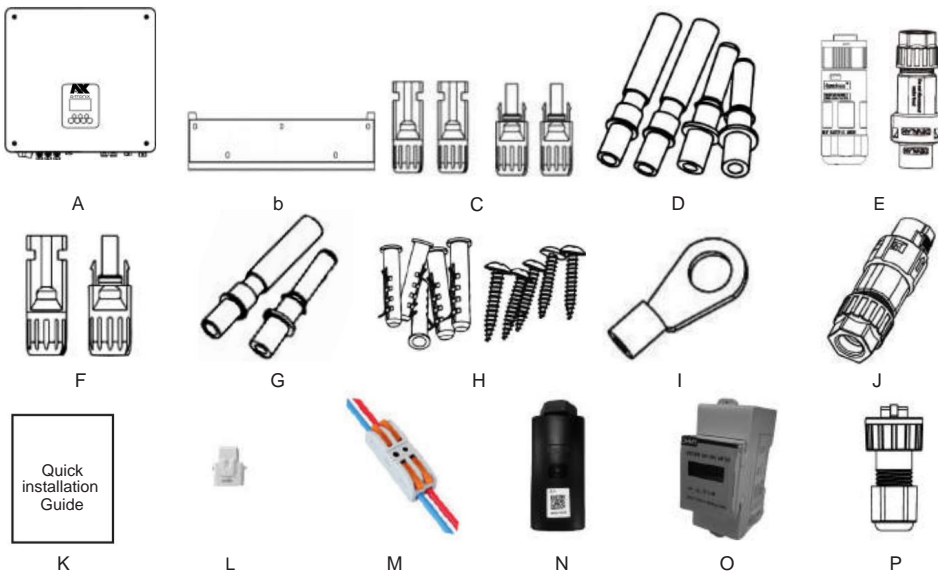

Object	Quantity	Description	Object	Quantity	Description
A	1	Inverters	I	1	Earth terminal
b	1	Bracket	J	1	Communication connector
C	4	PV connectors (for hybrid only) (2*positive, 2*negative)	K	1	Quick installation guide
D	4	PV pin contacts (for hybrid only) (2*positive, 2*negative)	L	1	CT (with 10m cable)
E	2	AC connectors	M	1	CT extension connector
F	2	Battery connectors (1*positive, 1*negative)	N	1	WiFi / LAN / 4G (Optional)
G	2	Battery pin contacts (1*positive, 1*negative)	O	1	Meters (Optional)
H	5	Expansion tubes & expansion screws	P	1	RJ45

5.3 Mounting

Installation Precaution

Make sure the installation site meets the following conditions:

- Not in direct sunlight.
- Not in areas where highly flammable materials are stored.
- Not in potentially explosive areas.
- Not in the cool air directly.
- Not near the television antenna or antenna cable.
- Not higher than altitude of about 2000m above sea level.
- Not in environment of precipitation or humidity (> 95%).
- Under good ventilation condition.
- The ambient temperature in the range of -25°C to +60°C.
- The slope of the wall should be within +5*.
- The wall hanging the inverter should meet conditions below:
 1. Solid brick/concrete, or strength equivalent mounting surface;
 2. Inverter must be supported or strengthened if the wall's strength isn't enough (such as wooden wall, the wall covered by thick layer of decoration).

Please avoid direct sunlight, rain exposure, snow laying up during installation and operation.

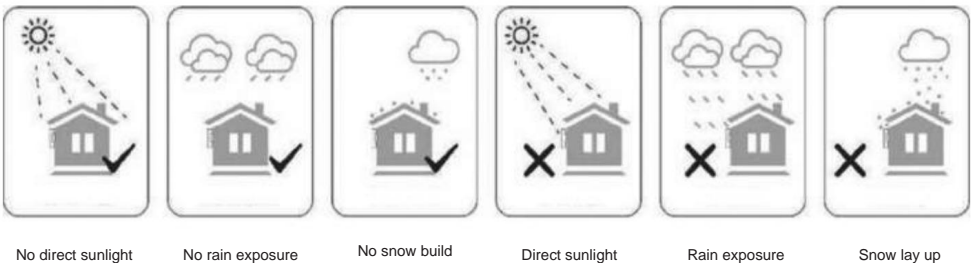

Space requirement

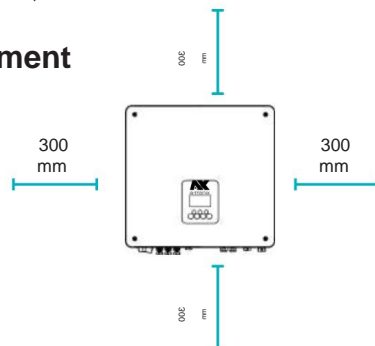

position	Minimum Distance
Left	300mm
Right	300mm
Top	300mm
Bottom	300mm
front	300mm

Mounting Steps

Tools required for installation:

- Manual wrench;
- Electric drill (drill bit set 8mm);
- Crimping pliers;
- Stripping pliers;
- Screwdriver.



Step 1: Fix the bracket on the wall

- Choose the place you want to install the inverter.

Place the bracket on the wall and mark the position of the 5 holes from bracket.

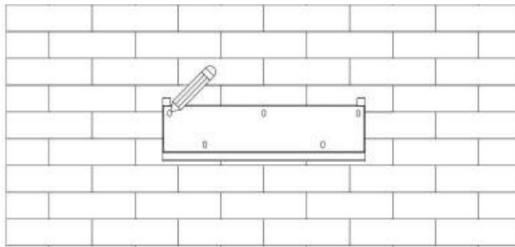

- Drill holes with electric drill, make sure the holes are at least 50mm deep, and then tighten the expansion tubes.

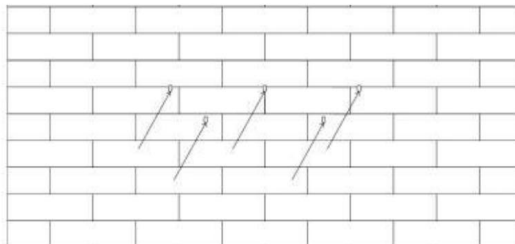

- Insert the expansion tubes into the holes and tighten them. Install the bracket with the expansion screws.

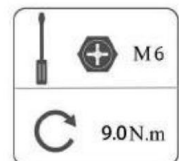
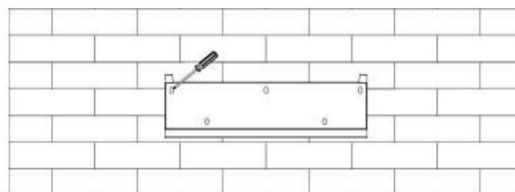

Step 2: Match the inverter with wall bracket •

Hang the inverter over the bracket, slightly lower the inverter, and make sure the 2 grooves on the back are fixed with the 2 mounting bars from bracket properly. Fixing inverter with the supplied M5 screw.

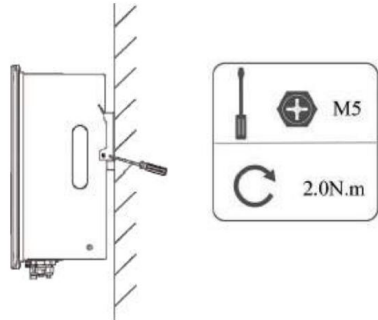
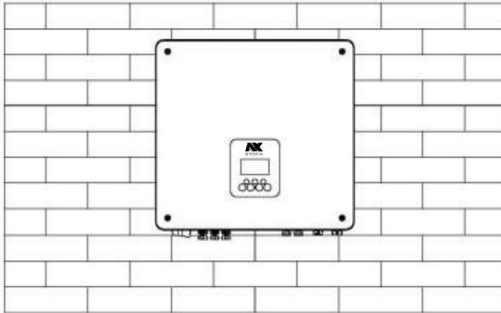

6. Electrical Connection

6.1 PV Connection (For Hybrid Only)

Step 1: PV String Connection

AX 1ph series inverters can be connected with 2-strings of PV modules. Please select suitable PV modules with high reliability and quality. Open circuit voltage of module array connected should be less than 600V, and operating voltage should be within the MPPT voltage range.



GRADE

Please choose a suitable external DC switch if the inverter does not have a built-in DC switch.



WARNING

- PV module voltage is very high and within a dangerous voltage range, please comply with the electrical safety rules when connecting.



- Please do not make PV positive or negative to ground!



GRADE

PV modules:

Please ensure they are the same type, have the same output and specifications, are aligned identically, and are tilted to the same angle.

In order to save cable and reduce DC loss, we recommend installing the inverter as close to the PV modules as possible.

GRADE



PV connection mode below is NOT allowed!

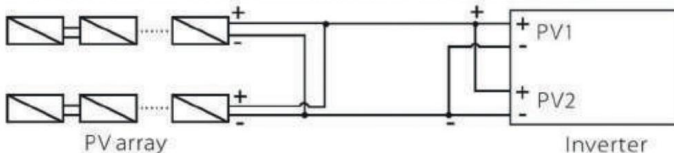

PV connection mode below is allowed!

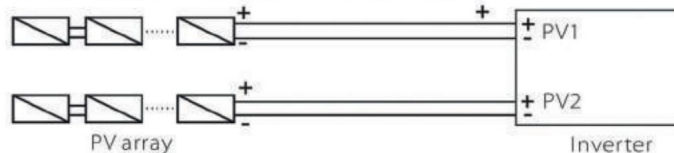

Step 2: PV wiring

- Turn off the DC switch.
- Choose 12 AWG wire to connect the PV module.
- Trim 6mm of insulation from the wire end.

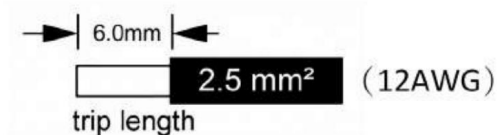

- Separate the DC connector (PV) as below.

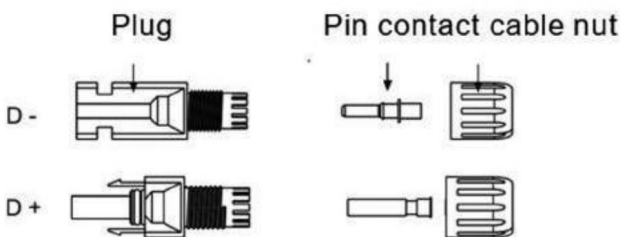

- Insert striped cable into pin contact and ensure all conductor strands are captured in the pin contact.
- Crimp pin contact by using a crimping plier. Put the pin contact with striped cable into the corresponding crimping pliers and crimp the contact.

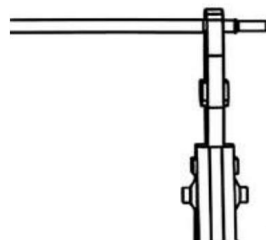

- Insert pin contact through the cable nut to assemble into back of the male or female plug. When you feel or hear a “click” the pin contact assembly is seated correctly.

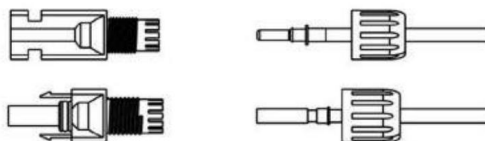

- Unlock the DC connector
 - Use the specified wrench tool.
 - When separating the DC + connector, push the tool down from the top.
 - When separating the DC connector, push the tool down from the bottom.
 - Separate the connectors by hand.

6.2 Battery Connection

- Turn off the DC switch. •

Choose 8 AWG wire to connect the battery. • Trim 6mm of insulation from the wire end.



- Separate the DC connector (battery) as below.

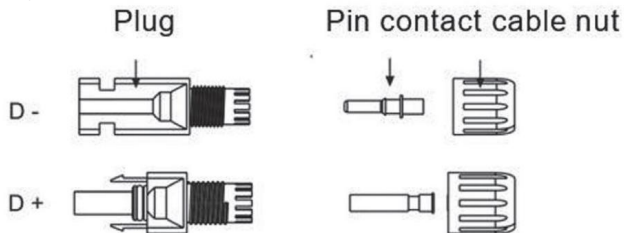

- Insert striped cable into pin contact and ensure all conductor strands are captured in the pin contact.
- Crimp pin contact by using a crimping plier. Put the pin contact with striped cable into the corresponding crimping pliers and crimp the contact.

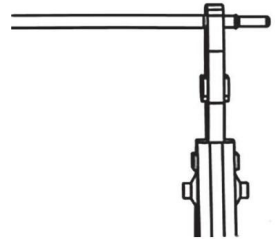

- Insert pin contact through the cable nut to assemble into back of the male or female plug. When you feel or hear a “click” the pin contact assembly is seated correctly.

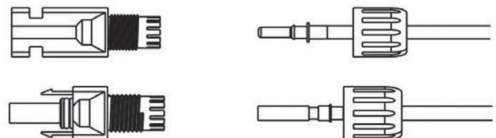

- Unlock the DC connector

- Use the specified wrench tool.
- When separating the DC + connector, push the tool down from the top.
- When separating the DC connector, push the tool down from the bottom.
- Separate the connectors by hand.

6.3 AC Connection

Step 1: AC String Connection

AX1ph series inverters are designed for single-phase grid. Voltage range is 220/230/240V; frequency is 50/60Hz. Other technical requests should comply with the requirement of the local public grid.

Table1: Without EPS Function (internal)

Model (kW)	3.0	3.7	4.6	5.0	6.0
Cable (GRID) (mm ²)	4.0		6.0		
Cable (EPS) (mm ²)	4.0		6.0		
Micro breaker (A)	25		32		40

Table2: With EPS Function (internal)

Model (kW)	3.0	3.7	4.6	5.0	6.0
Cable (GRID) (mm ²)	8.0-10.0				
Cable (EPS) (mm ²)	4.0		6.0		
Micro breaker (A)	50		63		

GRADE



1. If you don't use the EPS function, the wiring conduct core section can refer to the parameters of table 1.
2. If you use the EPS function, the wiring conduct core section can refer to the parameters of table 2.
3. A micro-breaker for max output overcurrent protection device shall be installed between inverter and grid, and the current of the protection device is referred to the table above, any load SHOULD NOT be connected to the inverter directly.

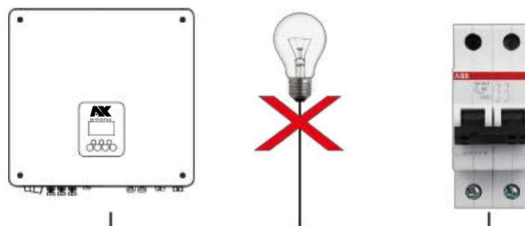

Step 2: AC Wiring

- Check the grid voltage and compare with the permitted voltage range (refer to technical data).
- Disconnect the circuit breaker from all the phases and secure against reconnection.
- Trim the wires:
 - Trim all the wires to 52.5mm and the PE wire to 55mm.
 - Use the crimping pliers to trim 12mm of insulation from all wire ends as below.

L: Brown/Red Wire

N: Blue/Black Wire

PE: Yellow & Green Wire

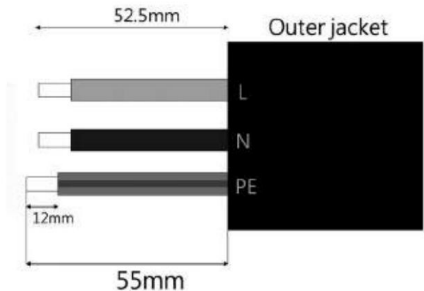

GRADE

Please refer to local cable type and color for actual installation.

A.EPS Wiring

- Run the cable into the sleeve assembly.
- Install the cable into the plug terminal and lock the screw, torque is $(0.8\pm 0.1\text{N}\cdot\text{m})$.

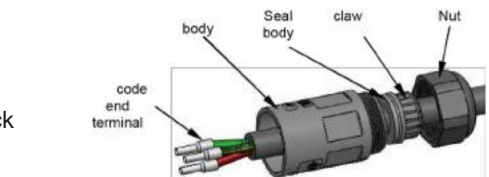
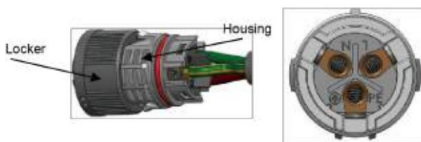

- Insert the plastic core into the main body.



- Put the sealing body and yarn trapper into the main body, screw the lock nut into the main body, and the torque is $(2.5\pm 0.5\text{N}\cdot\text{m})$.



- Insert the male end into the female end. For the rotation direction of the lock, please refer to the LOCK mark on the assembly.



- Push the threaded sleeve to connect terminal until both are locked tightly on the inverter.

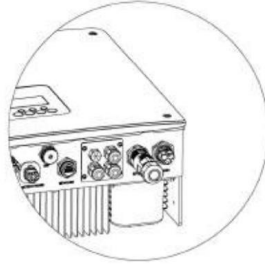

B. GRID Wiring

- Separate the GRID plug into three parts as below.
 - Hold middle part of the female insert, rotate the back shell to loosen it, detach it from female inset.
 - Remove the cable nut (with rubber insert) from the back shell.

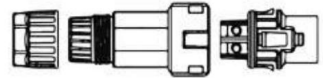

- Slide the cable groove and then the back shell onto the cable. Install the cable into the plug terminal and lock the screw, torque is (2.0+/-0.2 Nm).

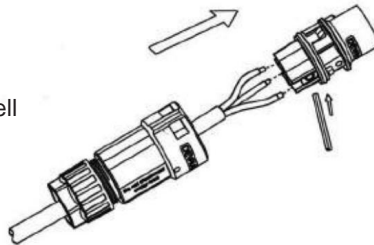

- Push the threaded sleeve into the socket, tighten up the cap on the terminal.

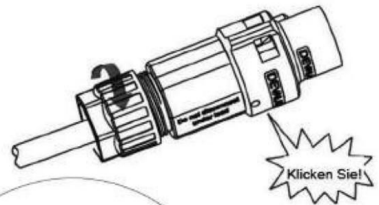

- Push the threaded sleeve to connection terminal until both are locked tightly on the inverter.

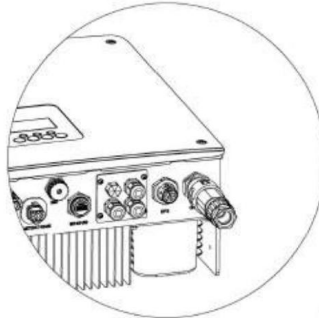

- Remove the AC connector:
Press the bayonet out of the slot with a small screwdriver or the unlock tool and pull it out, or unscrew the threaded sleeve, then pull it out.

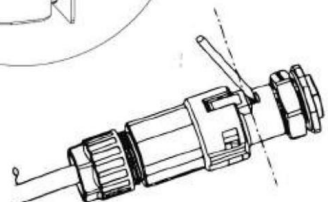

6.4 Earth Connection

Screw the ground screw with screwdriver as shown below:



6.5 Communication Device Installation (Optional)

AX 1ph series inverter are available with multiple communication options such as WiFi, LAN, 4G, RS485 and Meter with an external device.

Operating information like output voltage, current, frequency, fault information, etc., can be monitored locally or remotely via these interfaces.

• WiFi/LAN/4G (Optional)

The inverter has an interface for WiFi/LAN/4G devices that allow this device to collect information from inverter; including inverter working status, performance etc., and update that information to monitoring platform (the WiFi/LAN/4G device is available to purchase from your local supplier).

Connection steps:

1. For LAN device:

Please complete the wiring between router and LAN device (please refer to the LAN product manual for more details).

2. Plug the WiFi/LAN/4G device into “WiFi/LAN/4G” port at the bottom of the inverter.

3. For WiFi devices:

Connect the WiFi with the local router, and complete the WiFi configuration (please refer to the WiFi product manual for more details).

4. Set-up the site account on the a-TroniX monitoring platform (please refer to the monitoring user manual for more details).

• Meters /CT/ RS485

The inverter has integrated export limitation functionality. To use this function, a power meter or a CT must be installed.

The PIN definitions of Meter/CT/485 interface are as below.



pin code	1	2	3	4	5	6	7	8th
definition	meter 485A	meter 485B	Loggers 485B	Loggers 485A	CT2+	CT2	CT1-	CT1+



GRADE

- CT1: For Hybrid/AC.
- CT2: Grid tied inverter (if have).
- Compatible Meter type: DDSU666 (CHINT), SDM230 (EASTRON).

CT:

This inverter has an integrated export management function. To enable this function, a power meter or CT must be installed. The CT should be clamped on the main live line of the grid side. The arrow on the CT should be pointing towards the grid. The white cable connects to CT+, and the black cable connects to CT-.

Meter/CT setting:

Short press the touch key to switch display or make the number+1. Long press the touch key to confirm your setting.

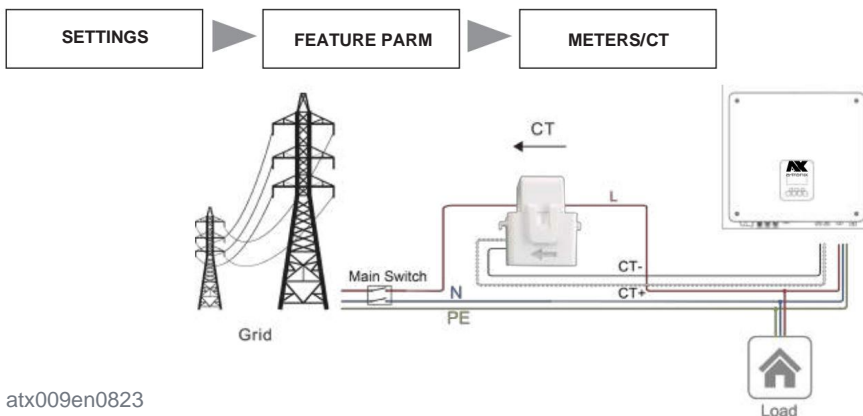

If there is another generator in the home, Meter2 or CT2 can be used to record the power generated by the generator and transmit the data to the website for monitoring.

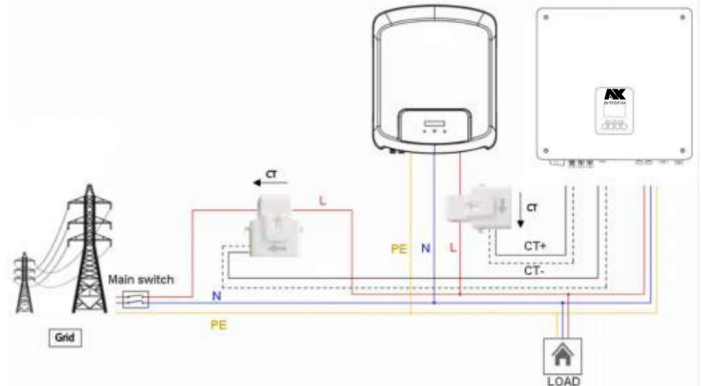

GRADE

For a precise reading and control of power, a meter can be used instead of a CT. If the CT is fitted in the wrong orientation, anti-backflow function will fail.

RS485:

RS485 is a standard communication interface which can transmit the real time data from inverter to PC or other monitoring devices.

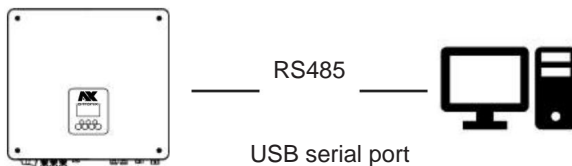

Meters (optional):

The inverter has integrated export limitation functionality. To use this function, a power meter or a CT must be installed. For Meter installation, please install it on the grid side.

Meter model	Factory	Current	Frequency	CT model	Factory	ratio
SDM230-Modbus	EASTRON	0.5%		0.2%	CTSA016 YUANXING	100A/33.33mA
DDSU666	CHINT		1%	1%	EICT-120K-T1000C	ELECMAT 120A/40mA

Export limitation setting:



The electricity meter is connected as follows:

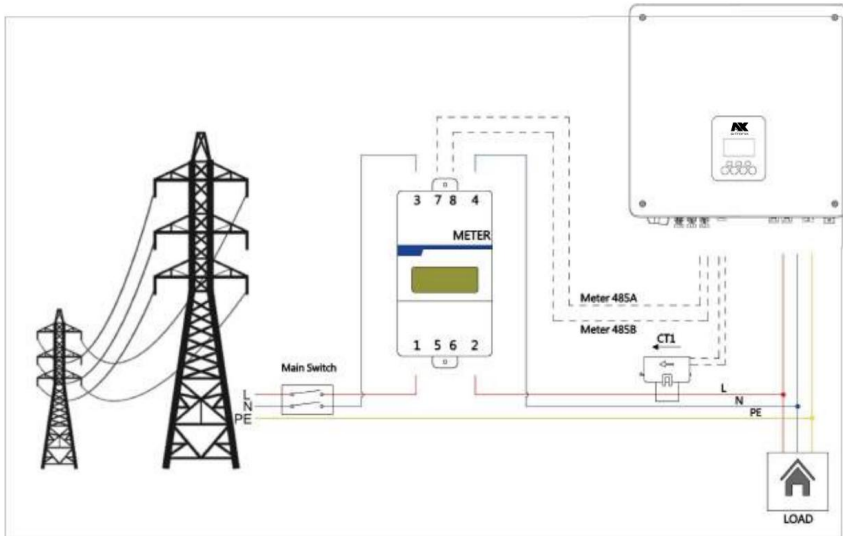

 **GRADE**
Meter type: DDSU666 (CHINT)

• BMS

Communication interface between inverter and battery is RS485 or CAN with a Rj45 connector.

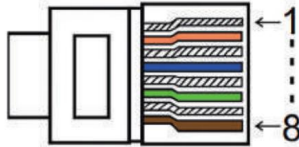

pin code	1	2	3	4	5	6	7	8th
definition	/	GND	BMS-485B	BMS-CANL	BMS-CANH	/	/	BMS-485A

Connection steps:

Step1:

Prepare a standard network cable and cable connector, then insert the network cable through the cable connector.



Step

2: Crimp the cable with a Rj45 plug which is inside of the cable connector.

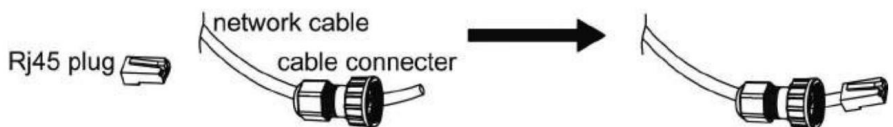

Step3:

Insert the cable connector into BMS port at the bottom of inverter and screw it tightly.



• DRM

DRM0 setting:



DRM is provided to support several demand response modes by emitting control signals as below.

Mode Requirement	
DRM0	Operate the disconnection device.
DRM1	Do not consume power.
DRM2	Do not consume at more than 50% of rated power.
DRM3	Do not consume at more than 75% of rated power and source reactive power if capable.
DRM4	Increase power consumption (subject to constraints from other active DRMs).
DRM5	Do not generate power.
DRM6	Do not generate at more than 50% of rated power.
DRM7	Do not generate at more than 75% of rated power and sink reactive power if capable.
DRM8	Increase power generation (subject to constraints from other active DRMs).



GRADE

Currently only supports DRM0 function, other functions are under development.

DRM PIN definition:

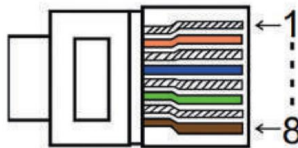

pin code	1	2	3	4	5	6	7	8
Definition	GND	GND	DRM0 +3.3V	DRM4/8	DRM3/7	DRM2/6	DRM1/5	

Model	Socket asserted by shorting pins		Function
ESTOP	1	2	Emergency stop the inverter.
DRM0	3	4	Operate the disconnection device.

• COM

ESTOP: Close the inverter.

Generator: Connect the generator and start-up it.

CAN: External debug.

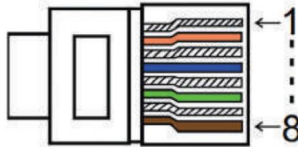

pin code	1	2	3	4	5	6	7	8th
Definition	+3.3V GND	GENERATOR	BMS-CANL	BMS-CANH	+3.3V GND	ESTOP		

Model	Socket asserted by shorting pins	Function
ESTOP	7 8th	Emergency stop the inverter

Connection steps:

Step

1: Screw this plate off from inverter.

Step2:

Prepare a standard network cable and cable connector, then insert the network cable through the cable connector.

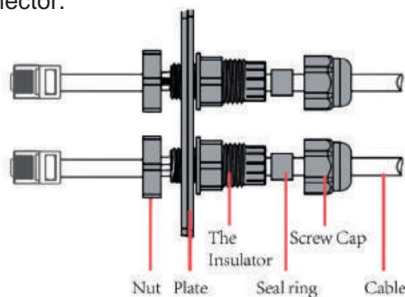

Step3:

Insert the cable connector into DRM/COM port at the bottom of inverter and screw it tightly. Then insert other side of the network cable into PC or other device.

6.6 EPS Connection

A.EPS Wiring

EPS mode can be achieved by two different types of wiring methods. One is using the internal bypass to wire the house emergency loads on the EPS port from inverter. Another is using external contactor to wire the EPS loads on the contactor itself (External contactor need to be purchased separately).



GRADE

The inverter default is set as “External” EPS wiring mode, it can be set to “Internal” via display setting “Menu – Setting – Feature – Bypass Relay”.

Use internal EPS wiring:

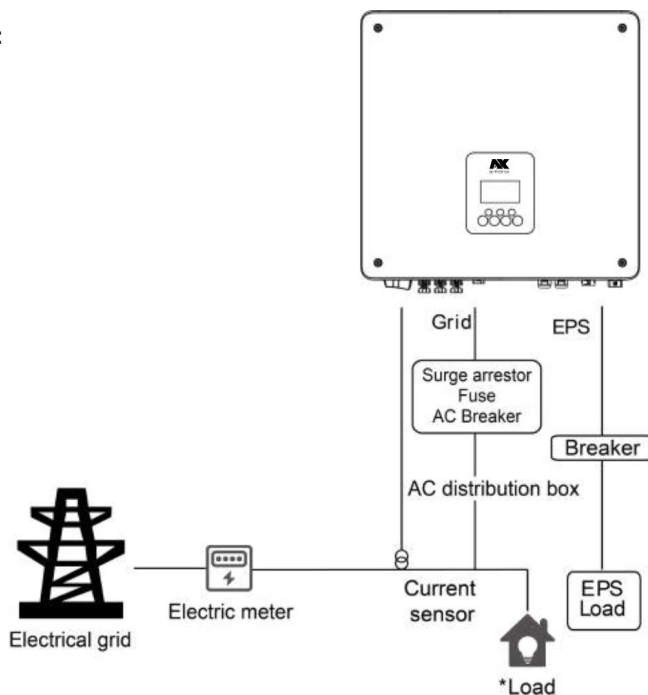

GRADE

1. Under On-grid mode, please ensure that the EPS loads power is lower than the inverter's maximum bypass power.
2. Under Off-grid mode, ensure that the EPS loads power is lower than the inverter's maximum EPS power.
3. We suggest not connect the inductive loads on EPS port.

Use External EPS Wiring:

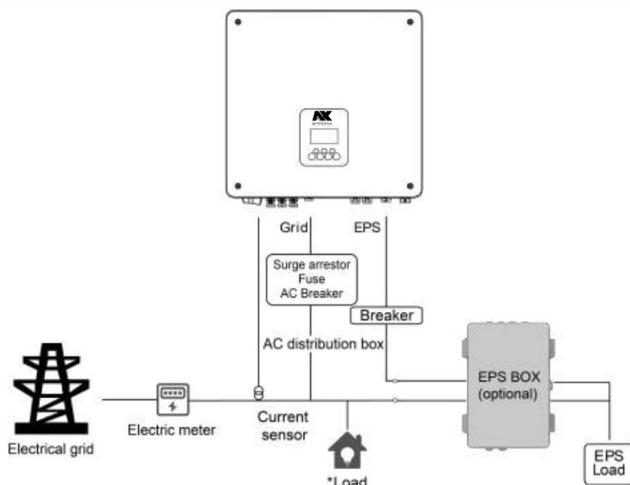

GRADE







1. EPS Box (Optional):

Used for On-Grid and EPS switching of inverters, improve maximum EPS loads capacity, maximum bypass current is 60A.

2. When the grid power is off, ensure that the back-up load power is lower than the inverter's maximum output power.

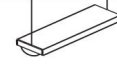
B. Common loads description

Under EPS mode, if need to connect the inductive load on EPS port, please ensure that the instantaneous power of the load at startup is lower than the maximum power of the EPS mode. Below table shows some conventional and reasonable loads for you reference. Please refer to your loads' manual for the actual specs.

Type	power		Common equipment	Example		
	Start	Rated		Equipment	begin	Rated
Resistive load	X1	X1	 Incandescent lamp  TV	 100W Incandescent lamp	100VA (W)	100VA (W)
Capacitive load	X2	X1.5	 Fluorescent lamp	 40W Fluorescent lamp	80VA(W)	60VA(W)
Inductive load	X3~5X2		 fan  Fridge	 150W Fridge	450~750 VA (W)	300VA (W)

6.7 System Connection Diagrams

Neutral line of alternative supply must be isolated or switched.

For countries such as Australia, New Zealand, South Africa, etc., please follow local writing regulations!

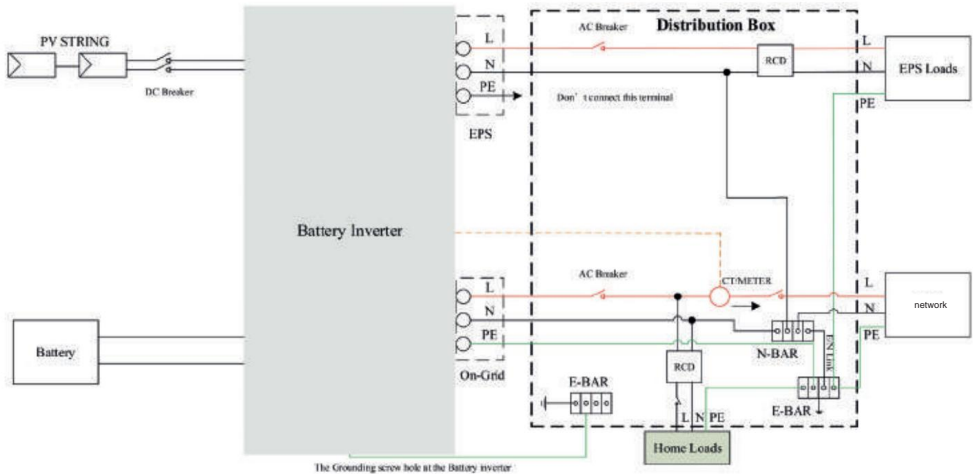

Neutral line of alternative supply must be disconnected after the grid is off.

For countries such as China, Germany, the Czech Republic, Italy, etc., please follow local writing regulations!

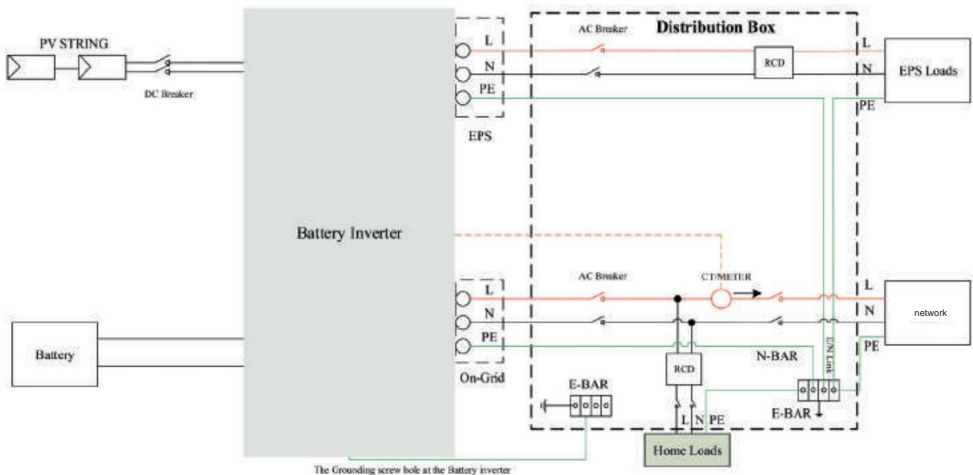

6.8 Inverter start-up

Please refer to the following steps to start up the inverter.

1. Ensure the inverter fixed well.
2. Make sure all the DC wirings and AC wirings are completed.
3. Make sure the meter is connected well.
4. Make sure the battery is connected well.
5. Make sure the external EPS contactor is connected well (if needed).
6. Turn on the PV/DC switch (for hybrid only), AC breaker, EPS breaker and battery breaker.
8. Enter the settings page, default password is '0000', select START / STOP and set it to start (long press “enter” to quickly go to the START / STOP page).



GRADE

- When starting the inverter for the first time, the country code will be set by default to the local settings. Please check if the country code is correct.
- Set the time on the inverter using the button or by using the APP.
- The internal bypass relay is closed by default, if it needs to be opened, enter the setting page, select “Internal”.
- EPS function is off by default, if it needs to be opened, enter the setting page, select EPS “ON/OFF”, default eps voltage/frequency is 230V and 50Hz.

6.9 Inverter Switch Off

Please refer to the following steps to switch off the inverter.

1. Enter the settings page, select START / STOP and set it to stop.
2. Turn off the PV/DC switch (for hybrid only), AC breaker, EPS breaker and battery breaker.
3. Wait 5 minutes before you open the upper lid (if in need of repair).

7. Surgery

7.1 Control Panel

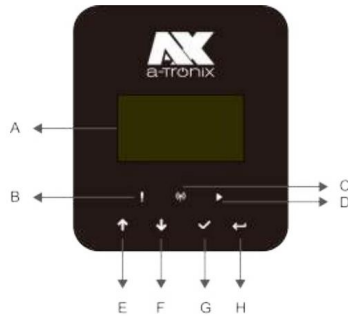

Object	Surname	Function
A	LCD screen	Display the information of the inverter.
b	Indicator LED	Red: The inverter is in fault mode.
C		Blue: The inverter is normally connected to the battery.
D		Green: The inverter is in normal state.
E	Function button	Up button: Move cursor to upside or increase value.
F		Down button: Move cursor to downside or decrease value.
G		OK button: Confirm the selection.
H		return button: Return the previous operation.

7.2 Function Tree

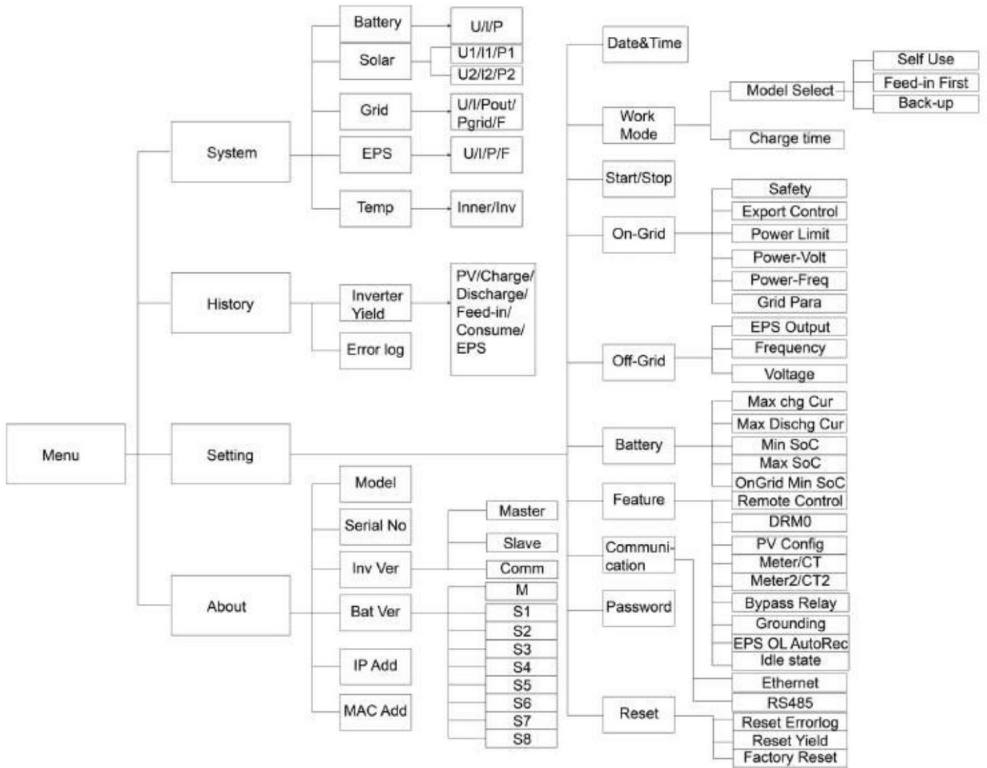

8.Maintenance

This section contains information and procedures for solving possible problems with the inverters and provides you with troubleshooting tips to identify and solve most problems that can occur.

8.1 Alarm List

Faulty code	Solution
Grid Lost Fault	<p>Grid is lost.</p> <ul style="list-style-type: none"> • System will reconnect if the utility is back to normal. • Or seek help from us, if not go back to normal state.
Grid Volts Fault	<p>Grid voltage out of range.</p> <ul style="list-style-type: none"> • System will reconnect if the utility is back to normal. • Or seek help from us, if not go back to normal state.
Grid Freq Fault	<p>Grid frequency out of range.</p> <ul style="list-style-type: none"> • System will reconnect if the utility is back to normal. • Or seek help from us, if not go back to normal state.
10min volts Fault	<p>The grid voltage is out of range for the last 10 minutes.</p> <ul style="list-style-type: none"> • System will reconnect if the utility is back to normal. • Or seek help from us, if not go back to normal state.
SW Inv Cur Fault	<p>Output current high detected by software.</p> <ul style="list-style-type: none"> • Disconnect PV, grid and battery, then reconnect. • Or seek help from us, if not go back to normal state.
DCI Fault	<p>DC component is out of limit in output current.</p> <ul style="list-style-type: none"> • Disconnect PV, grid and battery, then reconnect. • Or seek help from us, if not go back to normal state.
HW Inv Cur Fault	<p>Output current high detected by hardware.</p> <ul style="list-style-type: none"> • Disconnect PV, grid and battery, then reconnect. • Or seek help from us, if not go back to normal state.
SW Bus Vol Fault	<p>Bus voltage out of range detected by software.</p> <ul style="list-style-type: none"> • Disconnect PV, grid and battery, then reconnect. • Or seek help from us, if not go back to normal state.
Bat Volt Fault	<p>Battery voltage fault.</p> <ul style="list-style-type: none"> • Check if the battery input voltage is within the normal range. • Or seek help from us.
SW Bat Cur Fault	<p>Battery current high detected by software.</p> <ul style="list-style-type: none"> • Disconnect PV, grid and battery, then reconnect. • Or seek help from us, if not go back to normal state.

Faulty code	Solution
Iso Fault	<p>The isolation has failed.</p> <ul style="list-style-type: none"> • Please check if the insulation of electrical wires is damaged. • Wait for a while to check if back to normal. • Or seek for help from us.
Res Cur Fault	<p>The residual current is high.</p> <ul style="list-style-type: none"> • Please check if the insulation of electrical wires is damaged. • Wait for a while to check if back to normal. • Or seek for help from us.
PV Volt Fault	<p>PV voltage out of range.</p> <ul style="list-style-type: none"> • Please check the output voltage of PV panels. • Or seek for help from us.
SW PV Cur Fault	<p>PV input current high detected by software.</p> <ul style="list-style-type: none"> • Disconnect PV, grid and battery, then reconnect. • Or seek help from us, if not go back to normal state.
Temp fault	<p>The inverter temperature is high.</p> <ul style="list-style-type: none"> • Please check if the environment temperature. • Wait for a while to check if back to normal. • Or seek for help from us.
Ground Fault	<p>The ground connection failed.</p> <ul style="list-style-type: none"> • Check the voltage of neutral and PE. • Check AC wiring. • Disconnect PV, grid and battery, then reconnect. • Or seek help from us, if not go back to normal state.
Over Load Fault	<p>Over load in on grid mode.</p> <ul style="list-style-type: none"> • Please check if the load power exceeds the limit. • Or seek for help from us.
EPS Over Load	<p>Overload in off grid mode.</p> <ul style="list-style-type: none"> • Please check if the eps load power exceeds the limit. • Or seek for help from us.
Bat Power Low	<p>The battery power is low.</p> <ul style="list-style-type: none"> • Wait the battery to be recharged. • Or seek for help from us.
HW Bus Vol Fault	<p>Bus voltage out of range detected by hardware.</p> <ul style="list-style-type: none"> • Disconnect PV, grid and battery, then reconnect. • Or seek help from us, if not go back to normal state.
HW Pv Cur Fault	<p>PV input current high detected by hardware.</p> <ul style="list-style-type: none"> • Disconnect PV, grid and battery, then reconnect. • Or seek help from us, if not go back to normal state.

Faulty code	Solution
HW Bat Cur Fault	Battery current high detected by hardware. <ul style="list-style-type: none"> • Disconnect PV, grid and battery, then reconnect. • Or seek help from us, if not go back to normal state.
SCI Fault	The communication between master and manager is fail. <ul style="list-style-type: none"> • Disconnect PV, grid and battery, then reconnect. • Or seek help from us, if not go back to normal state.
MDSP SPI Fault	The communication between master and slave fails. <ul style="list-style-type: none"> • Disconnect PV, grid and battery, then reconnect. • Or seek help from us, if not go back to normal state.
MDSP Smpl Fault	The master sample detection circuit failed. <ul style="list-style-type: none"> • Disconnect PV, grid and battery, then reconnect. • Or seek help from us, if not go back to normal state.
Res Cur HW Fault	Residual current detection device failed. <ul style="list-style-type: none"> • Disconnect PV, grid and battery, then reconnect. • Or seek help from us, if not go back to normal state.
Inv EEPROM Fault	The inverter eeprom is faulty. <ul style="list-style-type: none"> • Disconnect PV, grid and battery, then reconnect. • Or seek help from us, if not go back to normal state.
PvCon Dir Fault	The PV connection is reversed. <ul style="list-style-type: none"> • Check if the positive pole and negative pole of PV are correct connected. • Or seek help from us.
Bat Relay Open	The battery relay keeps open. <ul style="list-style-type: none"> • Disconnect PV, grid and battery, then reconnect. • Or seek help from us, if not go back to normal state.
Bat Relay Short circuit	The battery relay keeps close. <ul style="list-style-type: none"> • Disconnect PV, grid and battery, then reconnect. • Or seek help from us, if not go back to normal state.
Bat Buck Fault	The battery buck circuit mosfet is failing. <ul style="list-style-type: none"> • Disconnect PV, grid and battery, then reconnect. • Or seek help from us, if not go back to normal state.
Bat Boost Fault	The battery boost circuit mosfet is failing. <ul style="list-style-type: none"> • Disconnect PV, grid and battery, then reconnect. • Or seek help from us, if not go back to normal state.
EPS relay Fault	The eps relay failed. <ul style="list-style-type: none"> • Disconnect PV, grid and battery, then reconnect. • Or seek help from us, if not go back to normal state.

Faulty code	Solution
BatCon Dir Fault	The battery connection is reversed. <ul style="list-style-type: none"> • Check if the positive pole and negative pole of battery are correctly connected. • Or seek help from us.
Main relay Open	The grid relay keeps open. <ul style="list-style-type: none"> • Disconnect PV, grid and battery, then reconnect. • Or seek help from us, if not go back to normal state.
S1 Close Fault	The grid relay S1 keep close. <ul style="list-style-type: none"> • Disconnect PV, grid and battery, then reconnect. • Or seek help from us, if not go back to normal state.
S2 Close Fault	The grid relay S2 keep close. <ul style="list-style-type: none"> • Disconnect PV, grid and battery, then reconnect. • Or seek help from us, if not go back to normal state.
M1 Close Fault	The grid relay M1 keep close. <ul style="list-style-type: none"> • Disconnect PV, grid and battery, then reconnect. • Or seek help from us, if not go back to normal state.
M2 Close Fault	The grid relay M2 keep close. <ul style="list-style-type: none"> • Disconnect PV, grid and battery, then reconnect. • Or seek help from us, if not go back to normal state.
GridV Cons Fault	The grid voltage sample value between master and slave is not consistent. <ul style="list-style-type: none"> • Disconnect PV, grid and battery, then reconnect. • Or seek help from us, if not go back to normal state.
GridF Cons Fault	The grid frequency sample value between master and slave is not consistent. <ul style="list-style-type: none"> • Disconnect PV, grid and battery, then reconnect. • Or seek help from us, if not go back to normal state.
Dci Cons Fault	The dci sample value between master and slave is not consistent. <ul style="list-style-type: none"> • Disconnect PV, grid and battery, then reconnect. • Or seek help from us, if not go back to normal state.
RC Cons Fault	The residual current sample value between master and slave is not consistent. <ul style="list-style-type: none"> • Disconnect PV, grid and battery, then reconnect. • Or seek help from us, if not go back to normal state.
RDSP SPI Fault	The communication between master and slave fails. <ul style="list-style-type: none"> • Disconnect PV, grid and battery, then reconnect. • Or seek help from us, if not go back to normal state.
RDSP SmpI Fault	The slave sample detection circuit failed. <ul style="list-style-type: none"> • Disconnect PV, grid and battery, then reconnect. • Or seek help from us, if not go back to normal state.
POOR EEPROM Fault	The manager eeprom is faulty. <ul style="list-style-type: none"> • Disconnect PV, grid and battery, then reconnect. • Or seek help from us, if not go back to normal state.
meters lost Fault	The communication between meter and inverter is interrupted. <ul style="list-style-type: none"> • Check if the communication cable between meter and inverter is correctly and well connected.

Faulty code	Solution
BMS Lost	The communication between BMS and inverter is interrupted. • Check if the communication cable between BMS and inverter is correct and well connected.
BMS Ext Fault	The communication between BMS and inverter is interrupted. • Check if the communication cable between BMS and inverter is correct and well connected.
BMS Int Fault	DIP switch at the wrong position; The communication between battery packs is interrupted. • Move the DIP switch to the correct position; • Check if the communication cable between battery packs is correct and well connected.
BMS Volt High	Battery over voltage. Please contact battery supplier.
BMS Volt Low	Battery under temperature. Please contact battery supplier.
BMS ChgCur High	Battery charge over current. Please contact battery supplier.
BMS DchgCur High	Battery discharge over current. Please contact battery supplier.
BMS Temp High	Battery over temperature. Please contact battery supplier.
BMS Temp Low	Battery under temperature. Please contact battery supplier.
BMS CellImbalance	The capacities of cells are different. Please contact battery supplier.
BMS HW Protect	Battery hardware under protection. Please contact battery supplier.
BMS Circuit Fault	Bms hardware circuit fault. Please contact battery supplier.
BMS Insul Fault	Battery insulation fault. Please contact battery supplier.
BMS VoltsSen Fault	Battery voltage sensor fault. Please contact battery supplier.
BMS TempSen Fault	Battery temperature sensor fault. Please contact battery supplier.
BMS CurSen Fault	Battery current sensor fault. Please contact battery supplier.
BMS type Unmatch	The capacity of battery packs is different. Please contact battery supplier.
BMS Ver Unmatch	The software between slaves are different. Please contact battery supplier.
BMS Mfg Unmatch	The cell manufacture is different. Please contact battery supplier.
BMS SwHw Unmatch	The slave software and hardware do not match. • Please contact battery supplier.
BMS M&S Unmatch	The software between master and slave are not match. • Please contact battery supplier.
BMS ChgReq NoAck	No action for charging request. Please contact battery supplier.

8.2 Troubleshooting and Routine Maintenance

• Troubleshooting

- a. Please check the fault message on the System Control Panel or the fault code on the inverter information panel. If a message is displayed, record it before doing anything further.
- b. Attempt the solution indicated in table above.
- c. If your inverter information panel is not displaying a fault light, check the following to make sure that the current state of the installation allows for proper operation of the unit:
 - (1) Is the inverter located in a clean, dry, adequately ventilated place?
 - (2) Have the DC input breakers opened?
 - (3) Are the cables adequately sized?
 - (4) Are the input and output connections and wiring in good condition?
 - (5) Are the configurations settings correct for your particular installation?
 - (6) Are the display panel and the communications cable properly connected and undamaged?

Contact Customer Service for further assistance. Please be prepared to describe details of your system installation and provide the model and serial number of the unit.

• Safety check

A safety check should be performed at least every 12 months by a qualified technician who has adequate training, knowledge and practical experience to perform these tests. The data should be recorded in an equipment log. If the device is not functioning properly or fails any of the tests, the device has to be repaired. For safety check details, refer to section 2 of this manual.

• Maintenance checking list

During the process of using the inverter, the responsible person shall examine and maintain the machine regularly. The required actions are as follows.

- Check that if the cooling fins at the rear of the inverters are collecting dust/ dirt, and the machine should be cleaned when necessary. This work should be conducted periodically.
- Check that if the indicators of the inverter are in normal state, check if the display of the inverter is normal. These checks should be performed at least every 6 months.

- Check if the input and output wires are damaged or aged. This check should be performed at least every 6 months.
- Get the inverter panels cleaned and their security checked at least every 6 months.

**GRADE**

Only qualified individuals may perform the following works.

9. Decommissioning

9.1 Dismantling the Inverter

- Disconnect the inverter from DC input and AC output. Wait for 5 minutes for the inverter to fully de-energize.
- Disconnect communication and optional connection wirings.
Remove the inverter from the bracket.
- Remove the bracket if necessary.

9.2 Packaging

If possible, please pack the inverter with the original packaging. If it is no longer available, you can also use an equivalent box that meets the following requirements.

- Suitable for loads more than 30kg.
- Contains a handle.
- Can be fully closed.

9.3 Storage and Transportation

Store the inverter in dry place where ambient temperatures are always between -40°C ~ $+70^{\circ}\text{C}$. Take care of the inverter during storage and transportation; keep less than 4 cartons in one stack. When the inverter or other related components need to be disposed of, please ensure it is carried out according to local waste handling regulations. Please be sure to deliver any inverter that needs to be disposed from sites that are appropriate for the disposal in accordance with local regulations.



www.a-tronix.de



atx009de-en0823



If you have any questions, please contact us!

AKKU SYS Accumulator and Battery Technology Nord GmbH

Connection path 23 · 25469 Halstenbek · GERMANY Telephone
+49 4101 37676-0 · info@akkusys.de www.akkusys.de ·
akkusys.shop · www.a-tronix.de